

MV-3716 / MV-3732

VoIP GSM Gateway

User Manual



MV-3716



MV-3732

PORTech Communications Inc.

【Content】

1. Introduction	1
2. Function description	1
3. Parts list	1
4. Dimension: 37*26*10 cm	2
5. Chart of the device	3
6. Web Page Setting	5
7. System Information	6
8. Dial Peer	7
8.1 Status.....	7
8.2 Settings.....	9
8.3 Prefix.....	13
8.4 Call Data to Server (CDR).....	17
9. Route	21
9.1 Mobile TO LAN Settings	21
9.2 Mobile to LAN Speed Dial Settings.....	24
9.3 LAN to Mobile Settings.....	25
10. Mobile	28
10.1 Mobile Status.....	28
10.2 Mobile Setting.....	29
10.3 Mobile / SMS Agent:.....	33
10.4 Send Bulk of SMS via Microsoft Excel	35
10.5 Use AT Command via Telnet or your program	43
10.6 USSD SIM BaLANce Check via Telnet.....	45
10.7 SIM Setting	47
10.8 Operator Setting.....	49
10.9 BCCH Info.....	51
10.10 USSD (Unstructured Supplementary Service Data).....	56
11. Network	60

11.1 WAN Setting	60
11.2 SNTP Settings.....	61
12. SIP Setting.....	62
12.1 Service Domain Setting	62
12.2 Ports Setting	64
12.3 Codec Settings:.....	65
12.4 Codec ID Setting.....	66
12.5 DTMF Setting	67
12.6 SIP Responses	68
12.7 Other Settings	70
13. STUN Setting.....	71
14. Update	72
14.1 Update Firmware	72
14.2 Default Settings.....	73
15. System Authority	74
16. Save Change	75
17. Reboot	76
18. Specification	77
18.1 Protocols	77
18.2 TCP/IP	77
18.3 Codec	77
18.4 Voice Quality	77
18.5 GSM (MV-3716/MV-3732).....	78
19. Simple Steps	79
20. Appendix: Setup MV-37x with Asterisk	80

1. Introduction

MV-3716/MV-3732 is a 16 / 32 channels VoIP GSM Gateway for call termination (VoIP to GSM) and origination (GSM to VoIP). It is SIP based and compatible with Asterisk. It can enable to make 16 / 32 calls simultaneously from IP phones to GSM networks and GSM network to IP phone.

2. Function description

2.1 VoIP(SIP) 、GSM conversion.

2.2 50 sets of LAN->MOBILE routes setting , 50 sets of MOBILE->LAN routes setting.

2.3 Voice response for setting and status (dial in from mobile).

2.4 Series connections to save bills.

2.5 Standard SIP(RFC2543,RFC3261) protocol ,

*It communicates with other gateway or PC.

3. Parts list

3.1 「MV-3716/MV-3732」 main body

3.2 Power adaptor

Output 12V/9A, Input 100~240V Auto switching

3.3 Network cable

3.4 Antenna: MV-3716: 4 pcs / MV-3732: 8 pcs

3.5 Rack-mount accessories (compatible with 19"Rack)

3.6 User Manual



(3.1) MV-3716



(3.1) MV-3732



(3.2) Power adapter



(3.3)



(3.4)



(3.5)

4. Dimension: 37*26*10 cm

5. Chart of the device

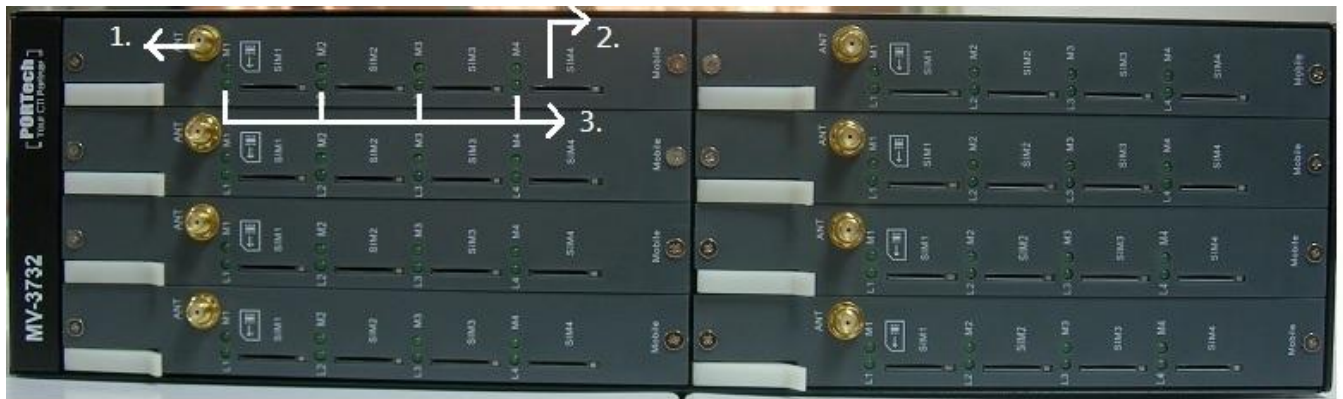

- 1 Antenna : Antenna Connector
2. SIM Holder: Insert the SIM card as instruction and hear click sound (the chip side down); Press the SIM to bottom with click sound to remove the SIM card
3. PWR (Power LED) : Light up when power is normal.



1. DC 12V : Power input.
2. WAN: RJ-45 internet connector
3. LAN: For maintenance use, not for any propose

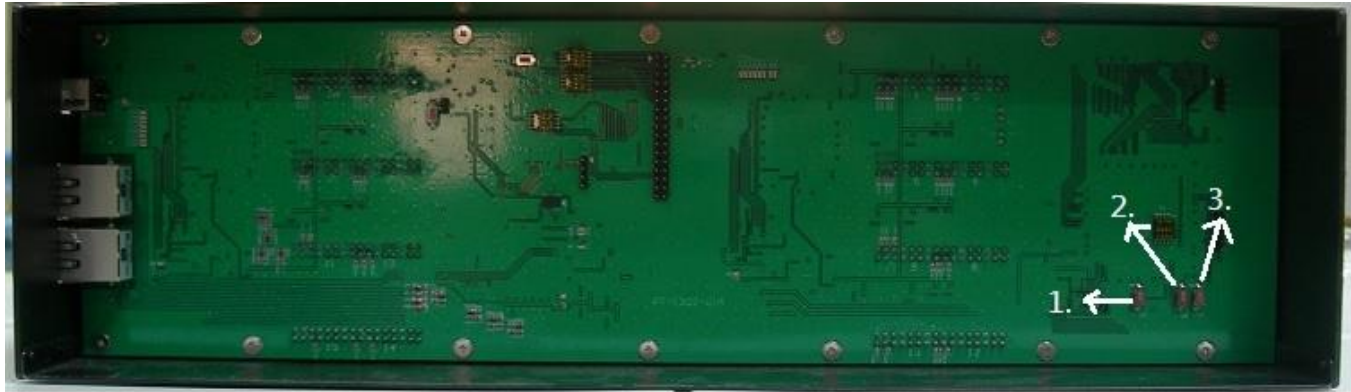

1. Dial Peer Reset Button
2. IP Reset Button:
Press this button about 10 seconds
IP restore back to 192.168.0.100
3. DHCP mode Button:
Press this button about 10 seconds and switch to DHCP mode

6. Web Page Setting

When the IP setting is done, the operator may setup all the rest parameters via web page. Browse the IP address from Internet Explorer (e.g. <http://192.168.0.100>). The following page shows up :



Enter the username and password for authentication. (Default username=voip, password=1234). The page follows when the username and password are correct.

7. System Information

User can see the demo system current system information like firmware version, company... etc in this page.

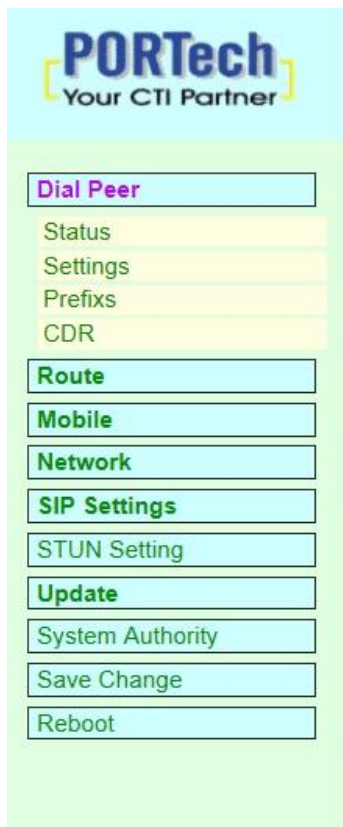

The screenshot shows the PORTech web interface. At the top left is the logo "PORTech Your CTI Partner". Below it is a vertical menu of system information options: "Dial Peer" (highlighted in purple), "Status", "Settings", "Prefixes", "CDR", "Route", "Mobile", "Network", "SIP Settings", "STUN Setting", "Update", "System Authority", "Save Change", and "Reboot".

MV-3732 v10.272

Module Description:	GSM:850/900/1800/1900MHz (M10)
Firmware Version:	Thu May 30 15:45:04 2013.
Codec Version:	Fri Mar 20 17:13:45 2009.
Contact Address:	150, Shiang-Shung N.Road., Taichung, Taiwan, R.O.C.
Tel:	886-4-23058000
Fax:	886-4-23022596
E-Mail:	sales@portech.com.tw
Web Site:	http://www.portech.com.tw

© 2013 [PORTech Communications Inc.](#)

8. Dial Peer

8.1 Status

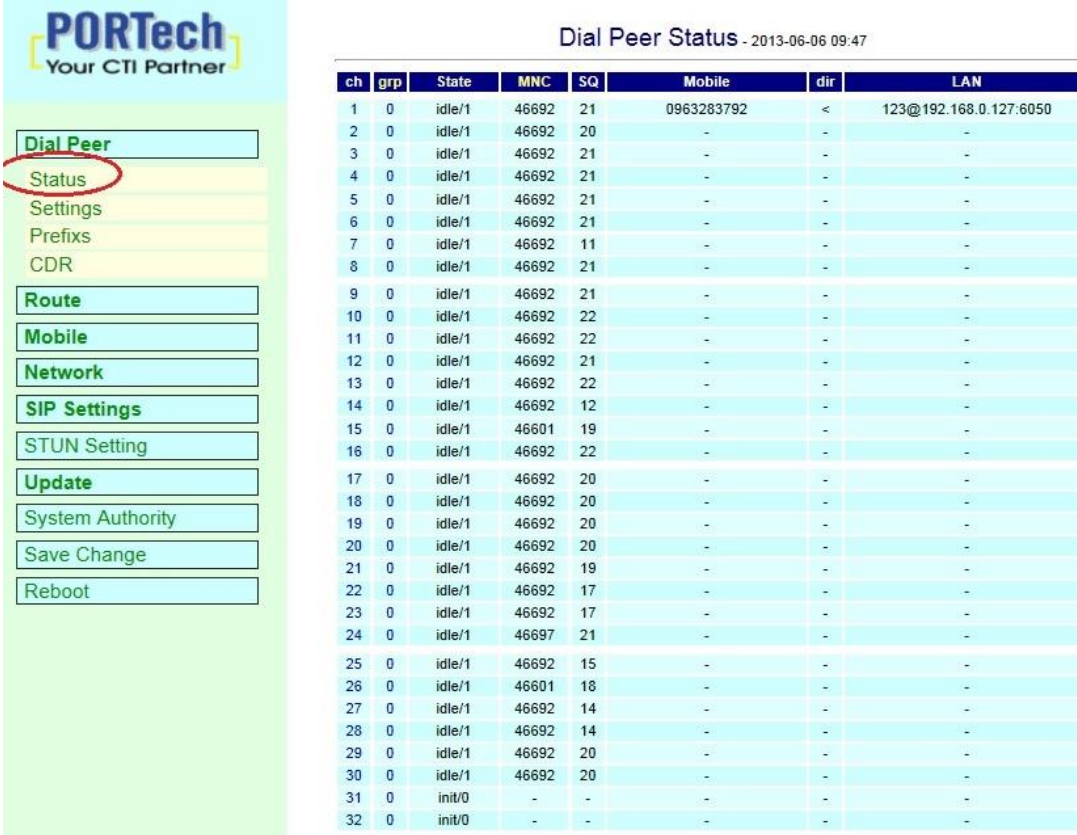

PORTech
Your CTI Partner

Dial Peer

Status

Settings

Prefixes

CDR

Route

Mobile

Network

SIP Settings

STUN Setting

Update

System Authority

Save Change

Reboot

Dial Peer Status - 2013-06-06 09:47

ch	grp	State	MNC	SQ	Mobile	dir	LAN
1	0	idle/1	46692	21	0963283792	<	123@192.168.0.127:6050
2	0	idle/1	46692	20	-	-	-
3	0	idle/1	46692	21	-	-	-
4	0	idle/1	46692	21	-	-	-
5	0	idle/1	46692	21	-	-	-
6	0	idle/1	46692	21	-	-	-
7	0	idle/1	46692	11	-	-	-
8	0	idle/1	46692	21	-	-	-
9	0	idle/1	46692	21	-	-	-
10	0	idle/1	46692	22	-	-	-
11	0	idle/1	46692	22	-	-	-
12	0	idle/1	46692	21	-	-	-
13	0	idle/1	46692	22	-	-	-
14	0	idle/1	46692	12	-	-	-
15	0	idle/1	46601	19	-	-	-
16	0	idle/1	46692	22	-	-	-
17	0	idle/1	46692	20	-	-	-
18	0	idle/1	46692	20	-	-	-
19	0	idle/1	46692	20	-	-	-
20	0	idle/1	46692	20	-	-	-
21	0	idle/1	46692	19	-	-	-
22	0	idle/1	46692	17	-	-	-
23	0	idle/1	46692	17	-	-	-
24	0	idle/1	46697	21	-	-	-
25	0	idle/1	46692	15	-	-	-
26	0	idle/1	46601	18	-	-	-
27	0	idle/1	46692	14	-	-	-
28	0	idle/1	46692	14	-	-	-
29	0	idle/1	46692	20	-	-	-
30	0	idle/1	46692	20	-	-	-
31	0	init/0	-	-	-	-	-
32	0	init/0	-	-	-	-	-

1. ch: The port of GSM channel
2. grp: the group of GSM channel
3. state:

INIT/0: GSM module is initialing
IDLE/0: GSM module not register
IDLE/1: GSM module registered
M.ringback/0: Ring Back
M.dialed/0: GSM port is dialed
M.listen/0: GSM port is engaged

-
4. MNC: Mobile Network Code
 5. SQ: Signal quality
 6. Mobile: The caller number of the incoming/outgoing call to Mobile
 7. dir: The Arrow shows the route to be LAN to Mobile or Mobile to LAN
 - a. < : LAN to Mobile
 - b. > : Mobile to LAN
 8. LAN: the IP address of the last incoming/outgoing call from/to LAN

8.2 Settings



Dial Peer Setting

Transfer SIP Message	
<input checked="" type="radio"/> Yes	<input type="radio"/> No
Replace contact to Dial Peer.	

SIP Response when all busy	
<input checked="" type="radio"/> 600	Busy Everywhere (default)
<input type="radio"/> 408	Request Timeout
<input type="radio"/> 480	Temporarily unavailable
<input type="radio"/> 503	Service unavailable

Dial Peer	
Working Mode	<input type="radio"/> OFF <input checked="" type="radio"/> Internal <input type="radio"/> External
External URL	<input type="text"/> (Dial Peer for XP)

1. Transfer SIP Message

The Replace contact to dial peer: The default is OFF, which won't send the SIP message to corresponding port through Dial Peer.

If ON, all SIP messages will send to corresponding port via Dial Peer.

2. SIP Response when all busy

User can select the corresponding response while all ports are busy.

The Default is 600

600 : Busy Everywhere (default)

408 : Request Timeout

480 : Temporarily unavailable

503: Service unavailable

3. Dial Peer

Working Mode→

- a. OFF: To disable Dial Peer, user need to assign the port of GSM channel for the incoming calls from LAN side (E.g. Default ch1 is 5064 port; ch2 should be 5066 port and so on)
- b. Internal: to motivate Dial Peer, all incoming calls from LAN will come to dial peer port. Dial peer will route calls to idle channels(Default: 5060 port)
- c. External: All GSM Channel are controlled by external Dial peer program.

External URL → External Dial peer program's IP address and port number

Edit DialPeer.ini (External Dial Peer)

[Window]
Xpos=512
Ypos=252
Width=471
Height=399

Total ip / port

[Info]
Total=16

[VoipIP]
1=192.168.0.100
2=192.168.0.100
3=192.168.0.100
4=192.168.0.100
5=192.168.0.100
6=192.168.0.100
7=192.168.0.100
8=192.168.0.100
9=192.168.0.110
10=192.168.0.110
11=192.168.0.110
12=192.168.0.110
13=192.168.0.110
14=192.168.0.110
15=192.168.0.110
16=192.168.0.110

The first
MV-378

The second
MV-378

[SipPort]

1=5060
2=5062
3=5064
4=5066
5=5068
6=5070
7=5072
8=5074
9=5060
10=5062
11=5064
12=5066
13=5068

The first
MV-378

The second
MV-378

14=5070
15=5072
16=5074

The second
MV-378

[RtpPort]

1=60000
2=60002
3=60004
4=60006
5=60008
6=60010
7=60012
8=60014

The first
MV-378

9=60000
10=60002
11=60004
12=60006
13=60008
14=60010
15=60012
16=60014

The second
MV-378

[PtcPort]

1=40000
2=40000
3=40008
4=40008
5=40016
6=40016
7=40024
8=40024

The first
MV-378

9=40000
10=40000
11=40008
12=40008
13=40016
14=40016
15=40024
16=40024

The second
MV-378

External Dial Peer Log

You can check the Statue here

Log	Status	Set	Event	CH	MvIP	port	sq	state	remote
1				1	192.168.0.111	5064	23	IDLE/1	192.168.0.96:5060
2				2	192.168.0.111	5066	22	IDLE/1	192.168.0.96:5060
3				3	192.168.0.111	5068	21	IDLE/1	192.168.0.96:5060
4				4	192.168.0.111	5070	21	IDLE/0	192.168.0.96:5060
5				5	192.168.0.111	5072	20	IDLE/1	192.168.0.96:5060
6				6	192.168.0.111	5074	21	IDLE/1	192.168.0.96:5060
7				7	192.168.0.111	5076	20	IDLE/1	192.168.0.96:5060
8				8	192.168.0.111	5078	20	IDLE/1	192.168.0.96:5060

1. CH: The number for GSM port of MV-37X
2. MvIP: The IP address of MV-37X for Dial Peer connection
3. Port: The corresponding port for MV-37X
4. Sq: Signal Quality for MV-37X GSM Port:
5. State: The GSM Port Sate status
 - INIT/1: GSM module is initialing
 - IDLE/0: GSM module is not register
 - IDLE/1: GSM module is registered
 - BUSY: GSM Port is busy
 - LISTEN: GSM port is engaged
 - OFF/0: GSM module is out of working
6. Remote: The VoIP Sender's IP

8.3 Prefix

User can setup the prefix number in 15 groups. Dial peer will route the calls based on the prefix settings of each group

PORTech
Your CTI Partner

Dial Peer

Status
Settings
Prefixes
CDR

Route

Mobile

Network

SIP Settings

STUN Setting

Update

System Authority

Save Change

Reboot

Prefix Settings

Group Enable: ON OFF

Group	Name	Prefixes
0	test	09
1		
2		
3		
4		
5		
6		
7		
8		
9		
10		
11		
12		
13		
14		
15		

submit reset

1. Group Enable

Off: The default is off.

On: Dial peer will route the calls based on the prefix settings of each group. And Dial Peer status will show the grp information as below.

PORTech
Your CTI Partner

Dial Peer

Status

Settings

Prefixes

CDR

Route

Mobile

Network

SIP Settings

STUN Setting

Update

System Authority

Save Change

Reboot

Dial Peer Status - 2013-06-06 09:38

ch	grp	State	MNC	SQ	Mobile	dir	LAN
1	0	idle/1	46692	21	0963283792	<	123@192.168.0.127:6050
2	0	idle/1	46692	20	-	-	-
3	0	idle/1	46692	21	-	-	-
4	0	idle/1	46692	21	-	-	-
5	0	idle/1	46692	21	-	-	-
6	0	idle/1	46692	21	-	-	-
7	0	idle/1	46692	12	-	-	-
8	0	idle/1	46692	21	-	-	-
9	0	idle/1	46692	21	-	-	-
10	0	idle/1	46692	22	-	-	-
11	0	idle/1	46692	22	-	-	-
12	0	idle/1	46692	21	-	-	-
13	0	idle/1	46692	23	-	-	-
14	0	idle/1	46692	12	-	-	-
15	0	idle/1	46601	18	-	-	-
16	0	idle/1	46692	22	-	-	-
17	0	idle/1	46692	19	-	-	-
18	0	idle/1	46692	20	-	-	-
19	0	idle/1	46692	20	-	-	-
20	0	idle/1	46692	20	-	-	-
21	0	idle/1	46692	19	-	-	-
22	0	idle/1	46692	20	-	-	-
23	0	idle/1	46692	19	-	-	-
24	0	idle/1	46697	21	-	-	-
25	0	idle/1	46692	15	-	-	-
26	0	idle/1	46601	18	-	-	-
27	0	idle/1	46692	17	-	-	-
28	0	idle/1	46692	14	-	-	-
29	0	idle/1	46692	20	-	-	-
30	0	idle/1	46692	20	-	-	-
31	0	init/0	-	-	-	-	-
32	0	init/0	-	-	-	-	-

Please click to select the group number of each channel

Dial Peer Status - 2013-06-06 09:57

ch	grp	State	MNC	SQ	Mobile	dir	LAN
1	0	idle/1	46692	21	0963283792	<	123@192.168.0.127:6050
2	0	idle/1	46692	20	-	-	-
3	0	idle/1	46692	22	-	-	-
4	0	idle/1	46692	21	-	-	-
5	0	idle/1	46692	21	-	-	-
6	0	idle/1	46692	21	-	-	-
7	0	idle/1	46692	12	-	-	-
8	0	idle/1	46692	21	-	-	-

After setting, please click submit button



- Dial Peer
- Route
- Mobile
- Network
- SIP Settings
- STUN Setting
- Update
- System Authority
- Save Change
- Reboot

Group Select

MCH	Prefixes Group
1	0: test (09) 1: 2: 3: 4: 5: 6: 7: 8: 9: 10: 11: 12: 13: 14: 15:

PORTech
Your CTI Partner

Dial Peer

Status

Settings

Prefixes

CDR

Route

Mobile

Network

SIP Settings

STUN Setting

Update

System Authority

Save Change

Reboot

Prefix Settings

Group Enable: ON OFF

Group	Name	Prefixes
0	test	09
1		
2		
3		
4		
5		
6		
7		
8		
9		
10		
11		
12		
13		
14		
15		

submit reset

- 2.Group: The group number, total is 15 sets
3. Name: Fill the name of the group
- 4.Prefixes: Fill the local area number or prefix numbers of the group

After all settings are done, please click submit button.

8.4 Call Data to Server (CDR)

It can provide Call Detail Record (CDR) for traffic and accounting management. User need to download external Dial Peer software on PC and can monitor traffic.

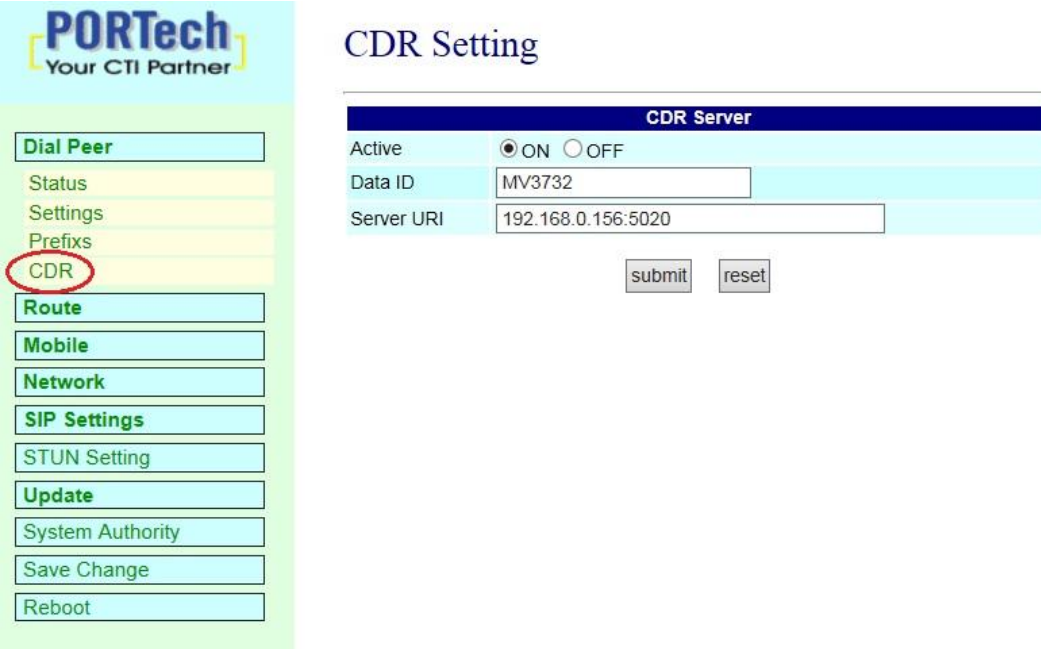

PORTech
Your CTI Partner

CDR Setting

CDR Server

Active ON OFF

Data ID

Server URI

Dial Peer

Status

Settings

Prefixes

CDR

Route

Mobile

Network

SIP Settings

STUN Setting

Update

System Authority

Save Change

Reboot

1.Data ID: MV will create one default Data ID

2.Server URL: Fill the IP and port of the CDR server

After the setting, please click Submit and save change button to wait for system reboot

External Dial Peer

You can check CDR Statue here

Dial Peer - (Apr 19 2011, 15:55:33)

File Help

Log	Status	Set	Event									
*	id	ch	cimi	lan	dir	mobile	tStart	tAns	tEnd	state	remark	
1	Mv-000000	7	466922102862561							idle		
2	Mv-000000	5	466921405104218							idle		
3	Mv-000000	4	466015800268726							idle		
4	Mv-000000	6	466015800268724							idle		
5	Mv-000000	8	466922102862549							idle		
6	Mv-000000	2	466923301930022							idle		
7	Mv-000000	3	466015400297468							idle		
8	Mv-000000	1	466922202956645	192.168.0.96	>	0980763178	2011/09/21 15:45:06		+26	idle		
9												
10												

1. ID: The MV's Data ID
2. CH: The GSM channel of MV-37X
3. Cimi: The SIM Card ID
4. LAN: Show the outgoing LAN IP or Incoming LAN IP
5. Dir: The Arrow shows the route to be LAN to Mobile or Mobile to LAN
6. Mobile: The outgoing mobile number or incoming mobile number
7. tStart: When the call started(date and time)
8. tANS: The second answering the call
9. tEND: The second ending the call(duration)
(tANS, tEND are the exactly talking seconds)
10. State: The GSM Port Sate status

CDR Files store at C:\Program Files\DialPeer

The CDR log is stored in this “cdr” file each hour, which includes all gsm port call details record.

If there’s no calls in this hour, it won’t create any log.



CDR File

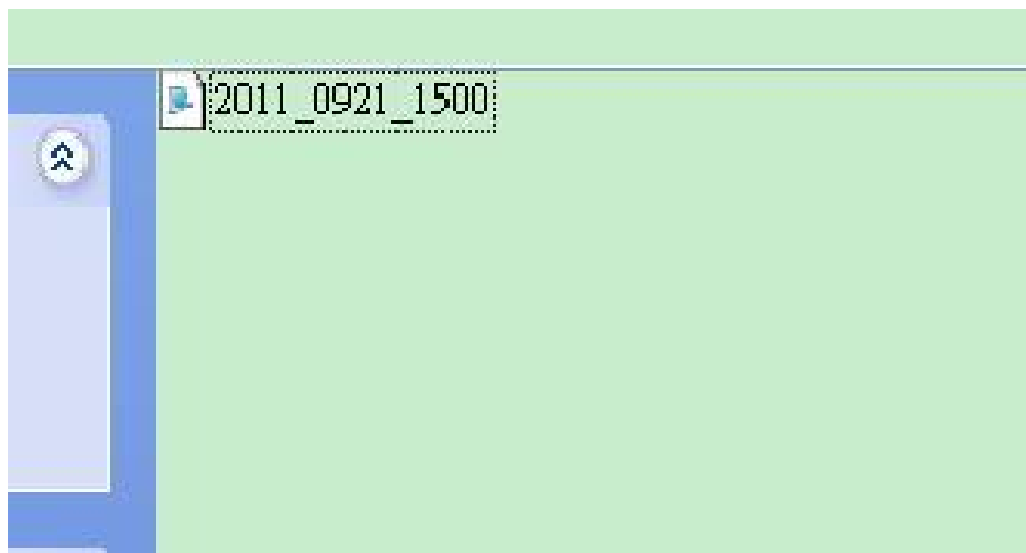

Example:

```
id=Mv-000000; ch=1; cimi=466922202956645; dir=L2M; iurl=192.168.0.96; omb=0980763178; tStart=4e7a0682(2011/09/21 15:45:06); tEnd=+26; state=LanEnd
```

1. Id=Mv-000000: The MV's Data ID
2. Ch=1: The 1st channel for MV ID
3. Cimi=466922202956645 : The SIM card ID for this GSM port
4. dir=L2M: The route is LAN to Mobile (If it's Mobile to LAN, that shows M2L)
5. iurl=192.168.0.96: The incoming IP
6. omb=0980763178: The outgoing number
7. tStart=4e7a0682(2011/09/21 15:45:06): The duration for the call
8. tEnd=+26: The call end on 26th second
9. state=LANEnd: The call hang up on LAN side.

9. Route

9.1 Mobile TO LAN Settings

User can assign the routing rule to transfer the call incoming on MOBILE to LAN



Mobile to LAN table

*: Click CID or URL data field to entry ...

MCH	CID	URL	SEL
1	*	*	<input type="checkbox"/>
2			<input type="checkbox"/>
3			<input type="checkbox"/>
4			<input type="checkbox"/>
5			<input type="checkbox"/>
6			<input type="checkbox"/>
7			<input type="checkbox"/>
8			<input type="checkbox"/>
9			<input type="checkbox"/>
10			<input type="checkbox"/>
11			<input type="checkbox"/>
12			<input type="checkbox"/>
13			<input type="checkbox"/>
14			<input type="checkbox"/>
15			<input type="checkbox"/>
16			<input type="checkbox"/>

Please move the mouse to that red arrow spot and click
It will show the setting bLANk. After the setting, please click Entry.

PORTech
Your CTI Partner

- Dial Peer
- Route
- Mobile**
- Network
- SIP Settings
- STUN Setting
- Update
- System Authority
- Save Change
- Reboot

Mobile to LAN table

*: Click CID or URL data field to entry ...

MCH	CID	URL	SEL
1	1 *	*	<input type="checkbox"/>
2			<input type="checkbox"/>
3			<input type="checkbox"/>
4			<input type="checkbox"/>
5			<input type="checkbox"/>
6			<input type="checkbox"/>
7			<input type="checkbox"/>
8			<input type="checkbox"/>
9			<input type="checkbox"/>
10			<input type="checkbox"/>
11			<input type="checkbox"/>
12			<input type="checkbox"/>
13			<input type="checkbox"/>
14			<input type="checkbox"/>
15			<input type="checkbox"/>
16			<input type="checkbox"/>

1. MCH: the code of mobile channel

2. CID:

(1) It may enter the whole number, e.g. 0911111111

(2) Only part of the number (prefix) e.g. 0911* means any number starting with 0911 will be accepted

(3) * means all numbers can be accepted

Please note the priority of the rules. The item which has more digits will have higher priority. If the digits are the same, then former one gets the higher priority.

3. URL : The IP address to transfer this call

(1) It may enter the whole IP address, e.g. 192.168.0.101 or proxy extension or phone number.

(2) If an '*' entered, it means 2-stages-dialing. The call will be answered and prompt dial tone again to receive the IP address/sip extension or **any phone number** as the destination. The caller may enter the

IP such as 192*168*0*101#.

*If the device have register proxy server/Asterisk ,you can enter any destination phone number. Please note the proxy server/Asterisk need to set the route of destination phone number.

4. SEL: Select the one to delete

9.2 Mobile to LAN Speed Dial Settings

NOTE: It's for 2 stage dialing mode

PORTech
Your CTI Partner

Dial Peer
Route
Mobile To Lan Settings
Mobile To Lan Speed Dial
Lan To Mobile Settings
Mobile
Network
SIP Settings
STUN Setting
Update
System Authority
Save Change
Reboot

Mobile To Lan Speed Dial

Mobile 1, 2 ▾

Item	Name	URL	Select
0	JACK	192.168.0.156	<input type="checkbox"/>
1			<input type="checkbox"/>
2			<input type="checkbox"/>
3			<input type="checkbox"/>
4			<input type="checkbox"/>
5			<input type="checkbox"/>
6			<input type="checkbox"/>
7			<input type="checkbox"/>
8			<input type="checkbox"/>
9			<input type="checkbox"/>

Delete Selected Delete All Reset

Add New

Position: (0~9)

Name:

URL:

Add Reset

The call will be answered and prompt dial tone again. When the caller may enter the "Num", system will connect the "URL" as destination.
E.g. item: 0 Name: JACK URL: 192.168.0.156,
When the caller hear dial tone and enter 0, system will connect 192.168.0.156

9.3 LAN to Mobile Settings

User can assign 24 sets of routing rule to transfer the call incoming from LAN to MOBILE. The chart setting is used for all channels.

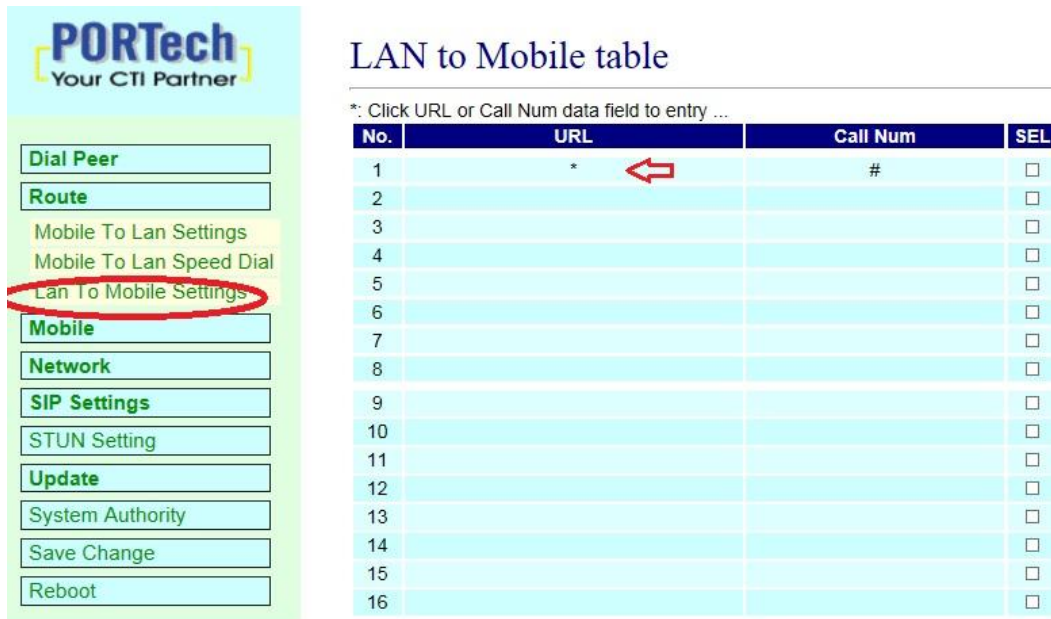

PORTech
Your CTI Partner

- Dial Peer
- Route
- Mobile To Lan Settings
- Mobile To Lan Speed Dial
- LAN To Mobile Settings**
- Mobile
- Network
- SIP Settings
- STUN Setting
- Update
- System Authority
- Save Change
- Reboot

LAN to Mobile table

*: Click URL or Call Num data field to entry ...

No.	URL	Call Num	SEL
1	*	#	<input type="checkbox"/>
2			<input type="checkbox"/>
3			<input type="checkbox"/>
4			<input type="checkbox"/>
5			<input type="checkbox"/>
6			<input type="checkbox"/>
7			<input type="checkbox"/>
8			<input type="checkbox"/>
9			<input type="checkbox"/>
10			<input type="checkbox"/>
11			<input type="checkbox"/>
12			<input type="checkbox"/>
13			<input type="checkbox"/>
14			<input type="checkbox"/>
15			<input type="checkbox"/>
16			<input type="checkbox"/>

Please move the mouse to that red arrow spot and click
It will show the setting bLANK. After the setting, please click Entry.

PORTech
Your CTI Partner

Dial Peer

Route

Mobile To Lan Settings
Mobile To Lan Speed Dial
Lan To Mobile Settings

Mobile

Network

SIP Settings

STUN Setting

Update

System Authority

Save Change

Reboot

LAN to Mobile table

*: Click URL or Call Num. data field to entry ...

No.	URL	Call Num	SEL
1	1 *	#	<input type="checkbox"/>
2			<input type="checkbox"/>
3			<input type="checkbox"/>
4			<input type="checkbox"/>
5			<input type="checkbox"/>
6			<input type="checkbox"/>
7			<input type="checkbox"/>
8			<input type="checkbox"/>
9			<input type="checkbox"/>
10			<input type="checkbox"/>
11			<input type="checkbox"/>
12			<input type="checkbox"/>
13			<input type="checkbox"/>
14			<input type="checkbox"/>
15			<input type="checkbox"/>
16			<input type="checkbox"/>
17			<input type="checkbox"/>
18			<input type="checkbox"/>
19			<input type="checkbox"/>
20			<input type="checkbox"/>
21			<input type="checkbox"/>
22			<input type="checkbox"/>
23			<input type="checkbox"/>
24			<input type="checkbox"/>

Select ALL Delete Selected Reset

1. No. : The code number

2. URL: It's the IP address of the incoming call

It may enter the whole IP address, e.g. 192.168.0.101 or proxy server's extension. If a simple "*" is entered, means no restriction for the incoming IP address.

3. Call Num:

(1). May enter the whole number, e.g. 0911111111

(2). A simple "*" means 2-stages-dialing. The call will be answered and prompt dial tone again to receive the called number as the destination, e.g. 0911111111 or 0911111111#

(3). # for one-stage dialing

(4). # ['d'n]['a'ppp] for one-stage-dialing

[...] is option

'd'n means to delete the beginning n codes,

'a'ppp means to add 'ppp' in front.

For example #d123a456 means one-stage dialing,

delete the first 123 from your destination number,

then add 456 in front as the new destination number.

Example:

LAN to Mobile: *, #

(1)MV-3716/MV-3732 and LAN Phone both need to register proxy server or Asterisk.

(2)Proxy server/asterisk set the route that the prefix of destination number

(3)When you dial any destination phone number from LAN phone, MV-3716/MV-3732 will connect this call auto.

4.SEL : Select the one to delete

10. Mobile

10.1 Mobile Status

PORTech
Your CTI Partner

Dial Peer
Route
Mobile
Status
Settings
SMS Agent
SIM Setting
Operator Setting
BCCH Info
USSD
Network
SIP Settings
STUN Setting
Update
System Authority
Save Change
Reboot

Mobile Status

2013-06-05 08:32

Mobile 1

Operator:	46692: Chunghwa Telecom
SIM Card ID:	466922102862553
Signal Quality:	20
Registration State:	0,1
GSM S/N:	862170016493106
Motion State:	Standby
Incoming URL:	
Incoming Name:	
Outgoing IP:	
Incoming Mob:	
Outgoing Mob:	

- (1) Choose Mobile 1,2,3 or 4 (MV-3732: Mobile 1,2,3,4,5,6,7,8)
- (2) Network Registration: The telecom carrier, which is the SIM card been registered.
- (3) SIM Card ID : SIM card ID. (4) Signal Quality : Signal quality.
- (5) GSM S/N: IMEI Number
- (6) Motion State: The status of SIM card
- (7) Incoming IP : The IP address of the last incoming call from LAN.
- (8) Incoming IP Name: proxy server name
- (9) Outgoing IP : The IP address of the last outgoing call to LAN.
- (10) Incoming Mob : The caller ID of the last incoming call from MOBILE.
- (11) Outgoing Mob: The called number of the outgoing call to MOBILE.

10.2 Mobile Setting



Mobile Setting

Mobile 1, 2

VoIP Tx Gain	<input type="text" value="9"/> (0~12)	VoIP Rx Gain	<input type="text" value="11"/> (0~15)
LAN Dialtone Vol	<input type="text" value="4"/> (0~12)		

Mobile 1 ON OFF

Routing Range	<input type="text" value="0"/> ~ <input type="text" value="24"/>		
CODEC Tx Gain	<input type="text" value="6"/> (0~7)	CODEC Rx Gain	<input type="text" value="6"/> (0~7)
SIP From:	<input type="text" value="Tel/User (Standard)"/> v	Answer delay	<input type="text" value="0"/> (0~15)
Hide Caller ID	<input type="radio"/> ON <input checked="" type="radio"/> OFF	Restart dial fails	<input type="text" value="1"/> (0~15)
PIN Code	On <input type="checkbox"/> Code: <input type="text"/>	Confirm:	<input type="text"/>
Dial Prefix	<input type="text"/>	LAN Answer Mode	<input type="text" value="Answered"/> v
Init AT Cmd	<input type="text"/>		

Mobile 2 ON OFF

Routing Range	<input type="text" value="25"/> ~ <input type="text" value="49"/>		
CODEC Tx Gain	<input type="text" value="6"/> (0~7)	CODEC Rx Gain	<input type="text" value="6"/> (0~7)
SIP From:	<input type="text" value="Tel/User (Standard)"/> v	Answer delay	<input type="text" value="0"/> (0~15)
Hide Caller ID	<input type="radio"/> ON <input checked="" type="radio"/> OFF	Restart dial fails	<input type="text" value="1"/> (0~15)
PIN Code	On <input type="checkbox"/> Code: <input type="text"/>	Confirm:	<input type="text"/>
Dial Prefix	<input type="text"/>	LAN Answer Mode	<input type="text" value="Answered"/> v
Init AT Cmd	<input type="text"/>		

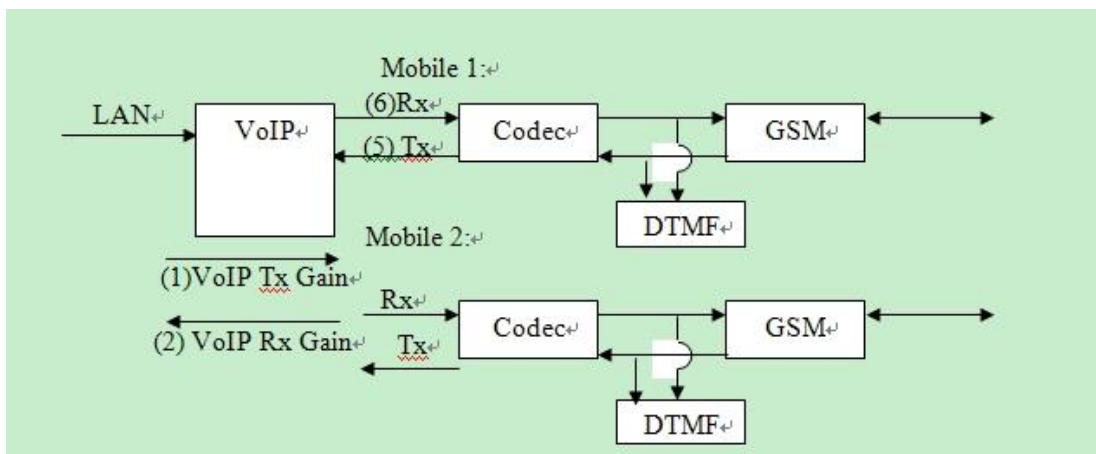

- (1) VoIP Tx Gain: To adjust the volume of LAN side.
- (2) VoIP Rx Gain: To adjust the volume of Mobile side.

(3)LAN Dial tone Gain: To adjust dial tone gain down of LAN.

(4)Routing Range: The route table -50 sets can share by two channels(1,2 ch / 3,4 ch / 5,6 ch / 7,8 ch)

ex: Mobile 1 use the route table for item 0-24,

Mobile 2 use the route table for item 25-49

(5)CODEC Tx Gain: as above

(6)CODEC Rx Gain: as above

(7) SIP From: Caller ID transfer

- Tel/User (Standard): If you need to register to Asterisk and proxy server, please choose this option. And how to transfer the caller ID to LAN, please refer 21.How to setup Asterisk to receive Caller ID from MV-3716/MV-3732 (page 42)

MV-3716/MV-3732 will send the message as follows in the Packet.

From: "caller number" <sip:3001@192.168.0.228>;tag=51088abb

- User/User (Standard): If you need to register to Asterisk and proxy server, please choose this option.

MV-3716/MV-3732 will send the message as follows in the Packet.

From: " 3001" <sip:3001@192.168.0.228>;tag=51088abb

- Tel/Tel :

MV-3716/MV-3732 will send the message as follows in the Packet.

From: "caller number" <sip: caller number @192.168.0.228>;tag=6ac93f7c

- ※Please note: If you choose this option, please don't register to Asterisk and proxy server. Please only fill **proxy server IP** and choose **Active: on**(else field empty) in sip setting/service domain

- User/Tel

MV-3716/MV-3732 will send the message as follows in the Packet.

From: "Username" <sip: caller number @192.168.0.228>;tag=7f130947

※ If you choose this option, please don't register to Asterisk and proxy server. Please only fill and choose (else field empty) in sip setting/service domain

(8) Answer Delay: Delay for incoming call when the ring.

(9) Presentation CLID: If you need to block the Caller Id for call termination, please choose Suppression

(10) Restart Dial Fail: In this feature, user can initialize and register the module while GSM module dials fail in couple times. When GSM module is dysfunctional, it can avoid the device shut down in advance.

(11) Mobile PIN Code: If you need to unlock pin code via MV-3716/MV-3732, you can click "On" and enter pin code.

(12) Dial Prefix: The prefix number of outgoing calls. When LAN to Mobile, MV-3716/MV-3732 will automatically add the "Dial prefix" for outgoing mobile.

(13) LAN Answer Mode:

Answered: when mobile answer, and then connect the call

Alerted: when the mobile is ringing back tone, then connect the call

Income: when LAN dial out, then connect soon

(14) Init AT Cmd: User can fill the AT Command for GSM module

(15) Band Type: You can manual setting according to your GSM Frequency of carrier.

(16) ON/Off: If you use this channel, please click on. Otherwise, please click off.

After the setting, please click Submit and save change button to wait for system reboot

You can click Submit All to copy to Mobile setting, and select Yes and save change to wait for the system reboot

Please check below:

Mobile Setting

Mobile 1, 2

VoIP Tx Gain	<input type="text" value="9"/> (0~12)	VoIP Rx Gain	<input type="text" value="11"/> (0~15)
LAN Dialtone Vol	<input type="text" value="4"/> (0~12)		

Mobile 1 <input type="radio"/> ON <input checked="" type="radio"/> OFF			
Routing Range	<input type="text" value="0"/> ~ <input type="text" value="24"/>		
CODEC Tx Gain	<input type="text" value="6"/> (0~7)	CODEC Rx Gain	<input type="text" value="6"/> (0~7)
SIP From:	<input type="button" value="Tel/User (Standard) v"/>	Answer delay	<input type="text" value="0"/> (0~15)
Hide Caller ID	<input type="radio"/> ON <input checked="" type="radio"/> OFF	Restart dial fails	<input type="text" value="1"/> (0~15)
PIN Code	On <input type="checkbox"/> Code: <input type="text"/>	Confirm:	<input type="text"/>
Dial Prefix	<input type="text"/>	LAN Answer Mode	<input type="button" value="Answered v"/>
Init AT Cmd	<input type="text"/>		

Mobile 2 <input type="radio"/> ON <input checked="" type="radio"/> OFF			
Routing Range	<input type="text" value="25"/> ~ <input type="text" value="49"/>		
CODEC Tx Gain	<input type="text" value="6"/> (0~7)	CODEC Rx Gain	<input type="text" value="6"/> (0~7)
SIP From:	<input type="button" value="Tel/User (Standard) v"/>	Answer delay	<input type="text" value="0"/> (0~15)
Hide Caller ID	<input type="radio"/> ON <input checked="" type="radio"/> OFF	Restart dial fails	<input type="text" value="1"/> (0~15)
PIN Code	On <input type="checkbox"/> Code: <input type="text"/>	Confirm:	<input type="text"/>
Dial Prefix	<input type="text"/>	LAN Answer Mode	<input type="button" value="Answered v"/>
Init AT Cmd	<input type="text"/>		

10.3 Mobile / SMS Agent:

PORTech
Your CTI Partner

SMS Agent

Mobile 1, 2

Port	Status	Bank
Mobile 1	Standby.	Rx List
Mobile 2	Standby.	Rx List

SMS Sender

Encode: ASC7 (ASCII 7bit)

Via: Mobile 1 2

Dest Num: []

Message: []

Maximum Number of ASC7 chars for this text box

You have 160 ASC7 chars remaining for your description.

Send Now

2 mode:
ASC7(ASCII 7 bit)
UCS2(Unicode 16 bit)

Read received SMS



1. Port: The GSM Channel No.
2. Status:
 - a. Standby: The GSM Channel is ready and idle for SMS sending
 - b. Not Ready: The GSM Channel is not registered or engaged, not able to send SMS
3. Encode : ASC7(ASCII 7 bit) or UCS2(Unicode 16 bit)
4. Via : To select the GSM Channel for SMS sending
5. Dest Num: the Receiver's phone number
6. Message: Please fill the message that wants to send to receiver.

After typing the SMS, please click Send Now button

When you click Rx List, you can view all received SMS as follows.

SMS Rx List

Mobile 1 

Read	Status	Caller ID	Date, Time
	REC READ	886935386862	08/05/15,15:41:46
			

Click the serial no, you can view message as follows.

SMS Reader

Index	RemotelD	Date, Time
1	886935386862	08/05/15, 15:41:46

MV Serial can send SMS and Receive SMS

10.4 Send Bulk of SMS via Microsoft Excel

First of all, please open a new Excel file.

Step 1 Format Cells

Here, we need you to format cells to "Text" first.

Please click mouse right key, and choose "Format Cells"

BLANK A

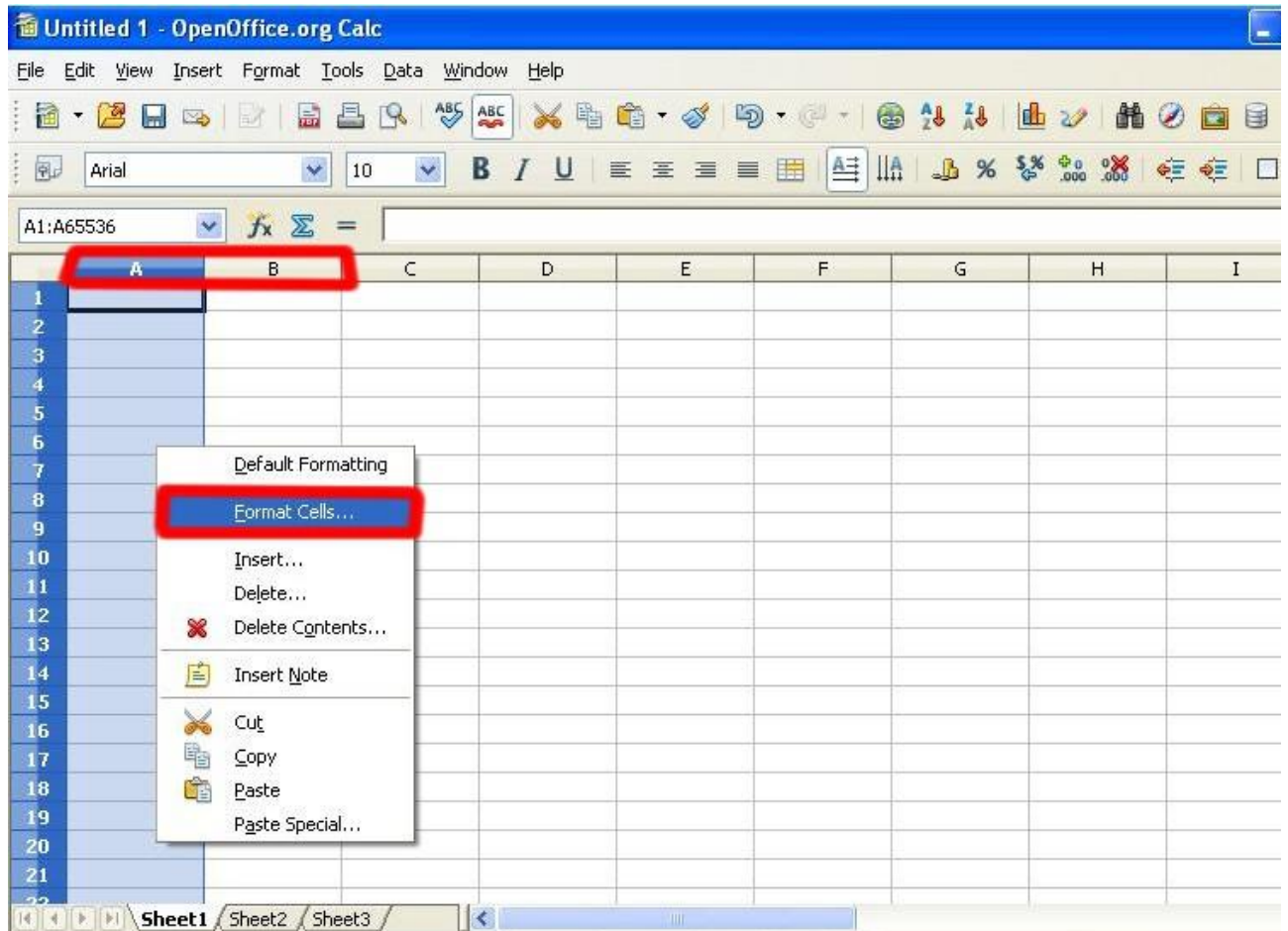

BLANK B

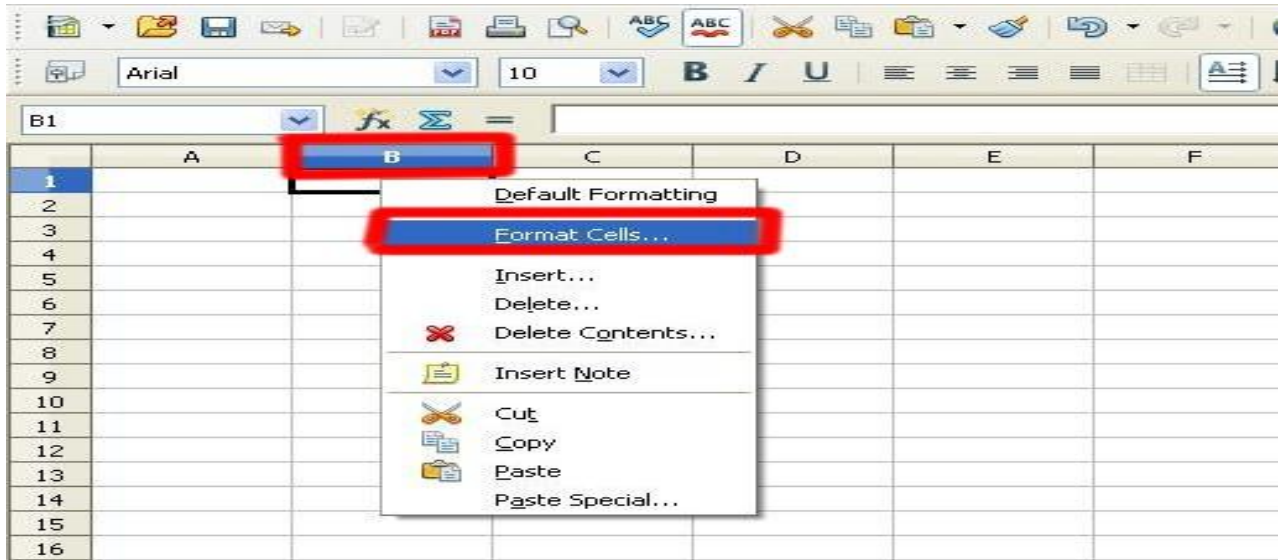

Step 2

In the Format Cells, please select “Text”

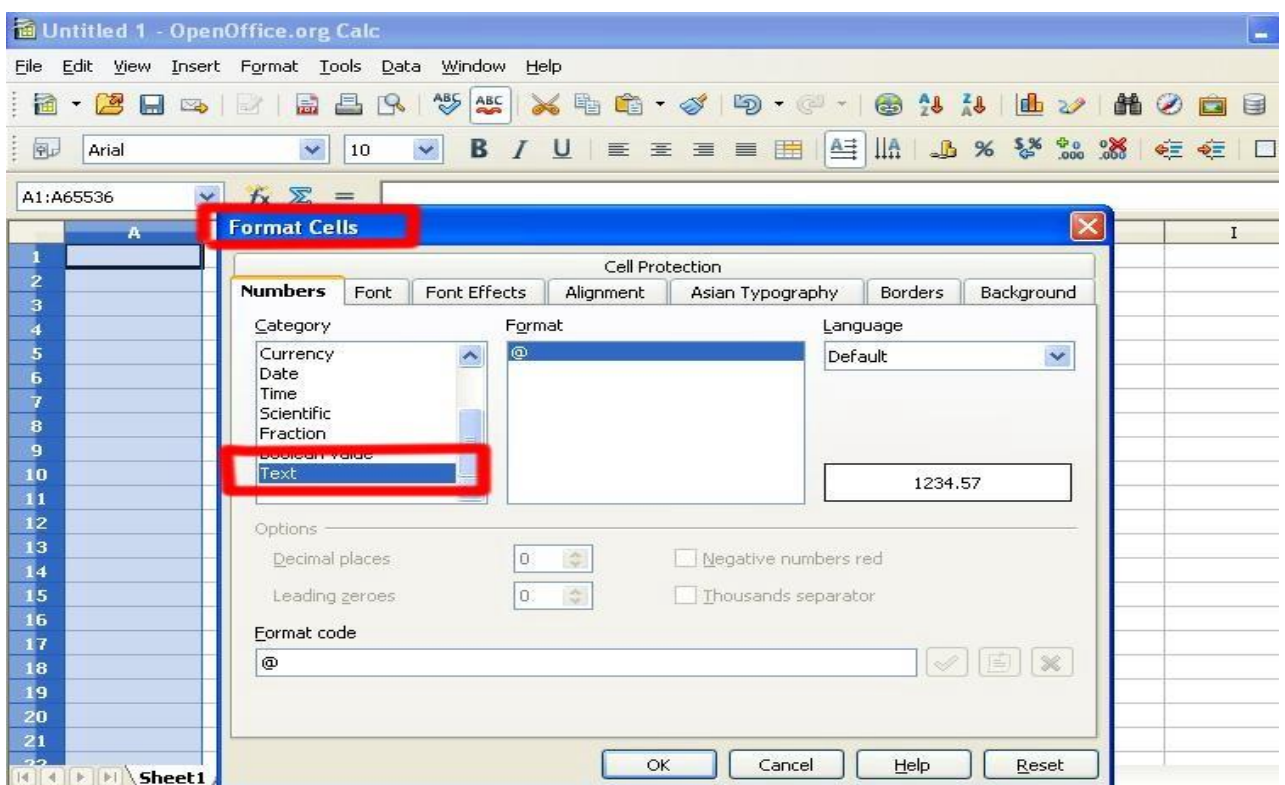

- Please do this action for BLANK A and B both.

Step 3

BLANK A: is for you to key “phone numbers”

BLANK B: is for you to key “text”

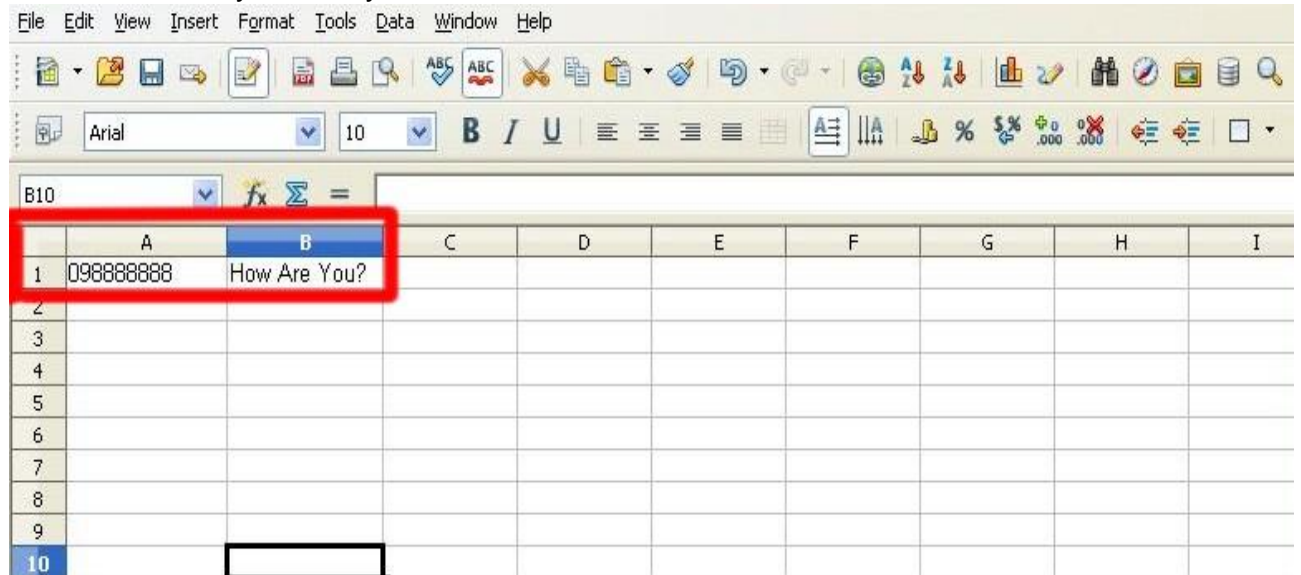

Step 4 save the file

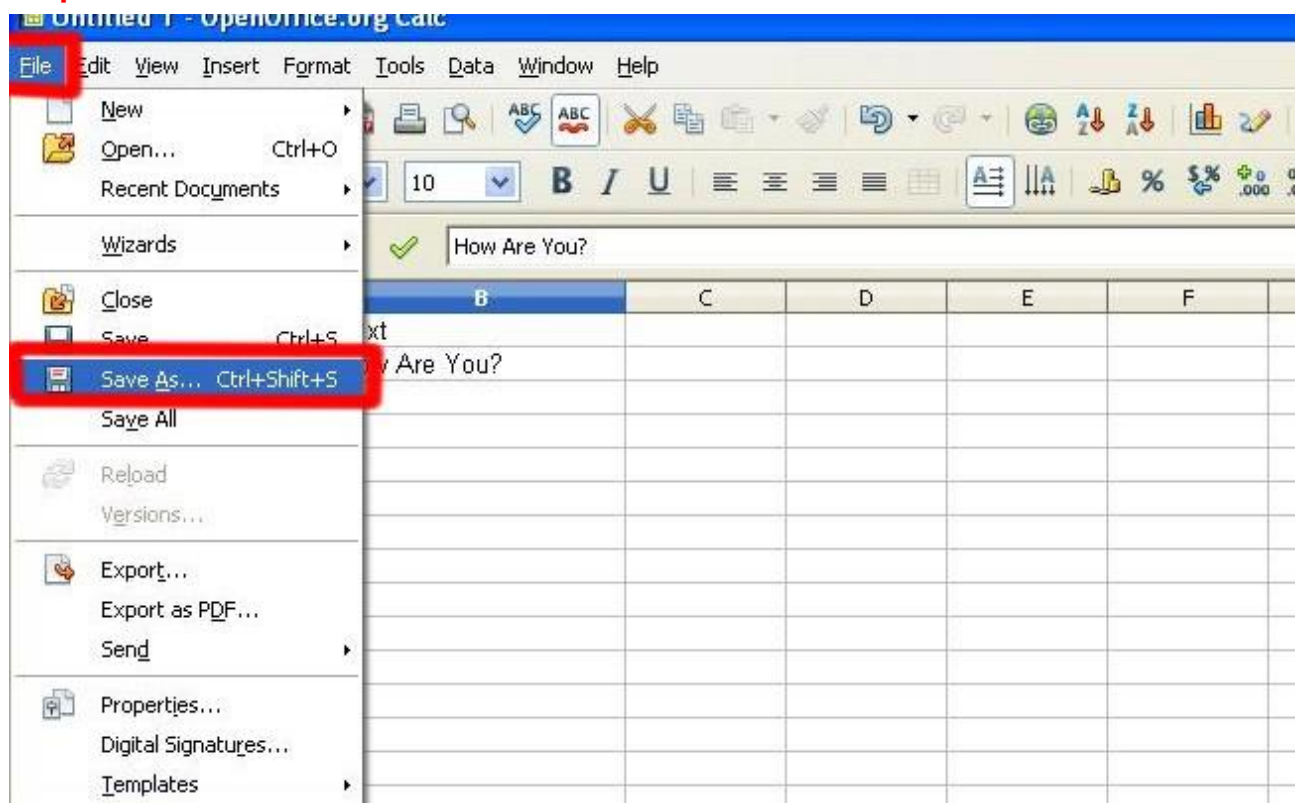

Save the type as **Unicode Text**

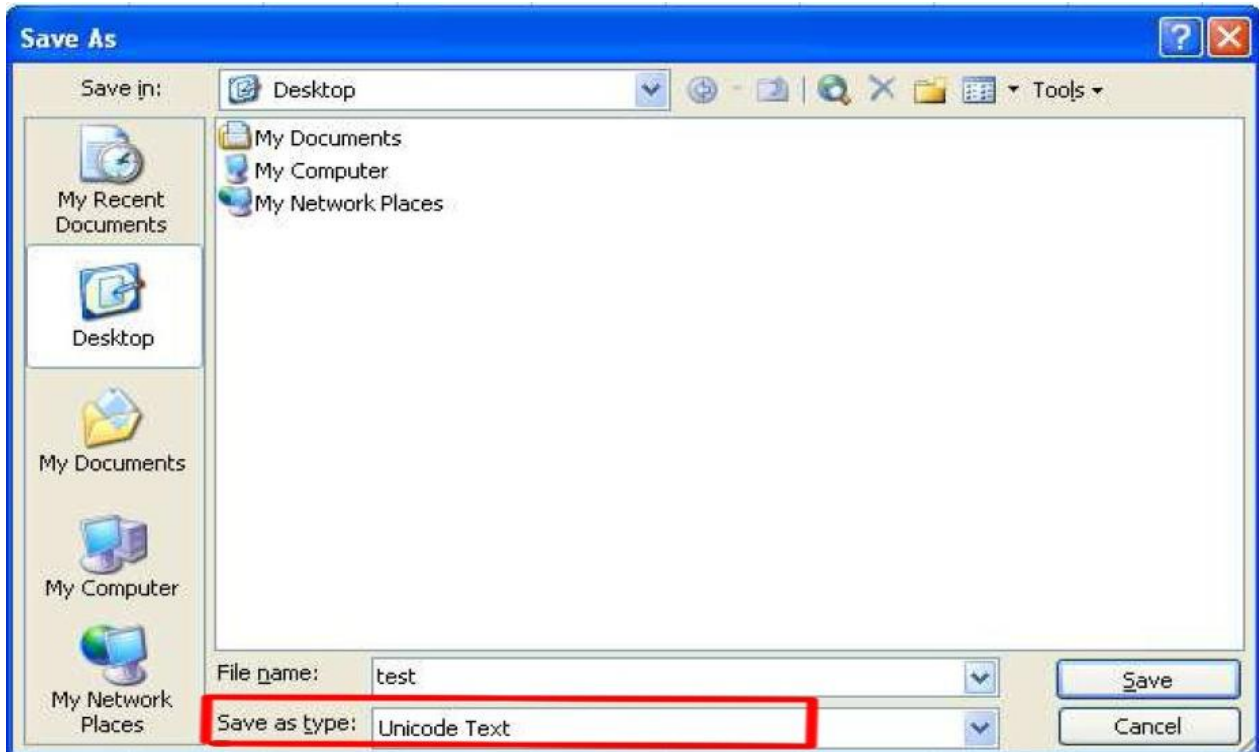

Step 5

Open MVsms_exe -> MV-SMS (Configuration Settings)

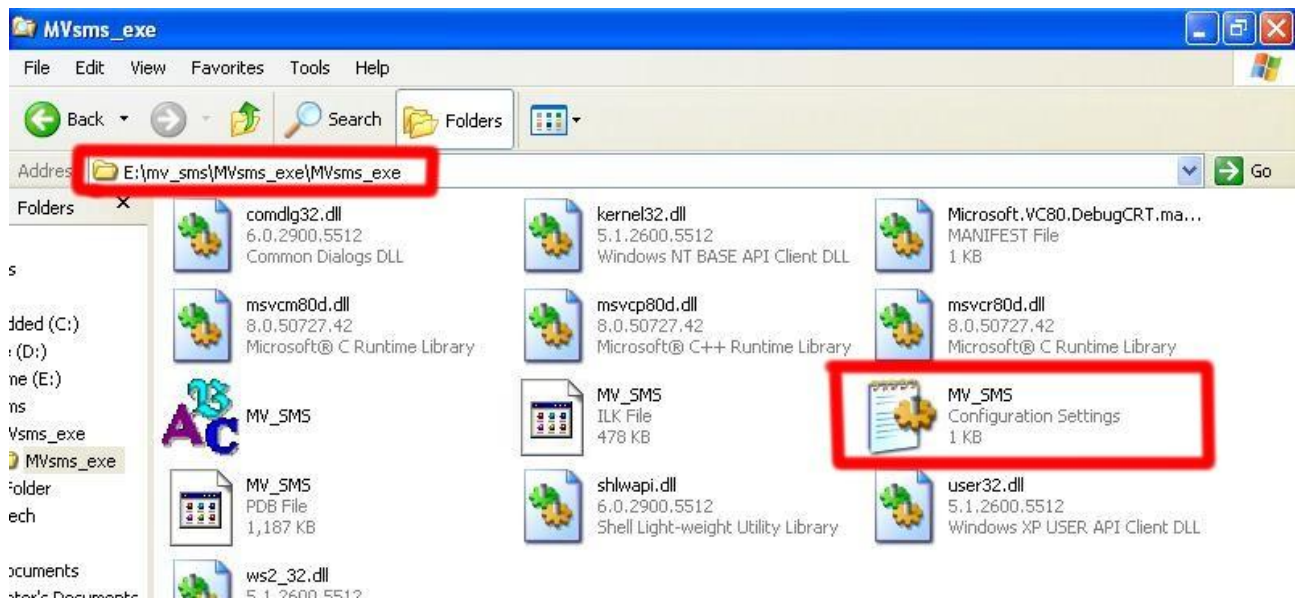



Step 6

Please do the configuration as following:

MV-3732

```
File Edit Format View Help
[info]
Total=4
[VOIP]
1=192.168.0.100
2=192.168.0.100
3=192.168.0.100
4=192.168.0.100
[PORT]
1=23
2=8023
3=8123
4=8223
[USER]
1=voip
2=voip
3=voip
4=voip
[PASS]
1=1234
2=1234
3=1234
4=1234
```

MV-3716

```
File Edit Format View Help
[info]
Total=2
[VOIP]
1=192.168.0.100
2=192.168.0.100
[PORT]
1=23
2=8023
[USER]
1=voip
2=voip
[PASS]
1=1234
2=1234
```

MV-372 & MV-370



Step 7

Run MV-SMS program

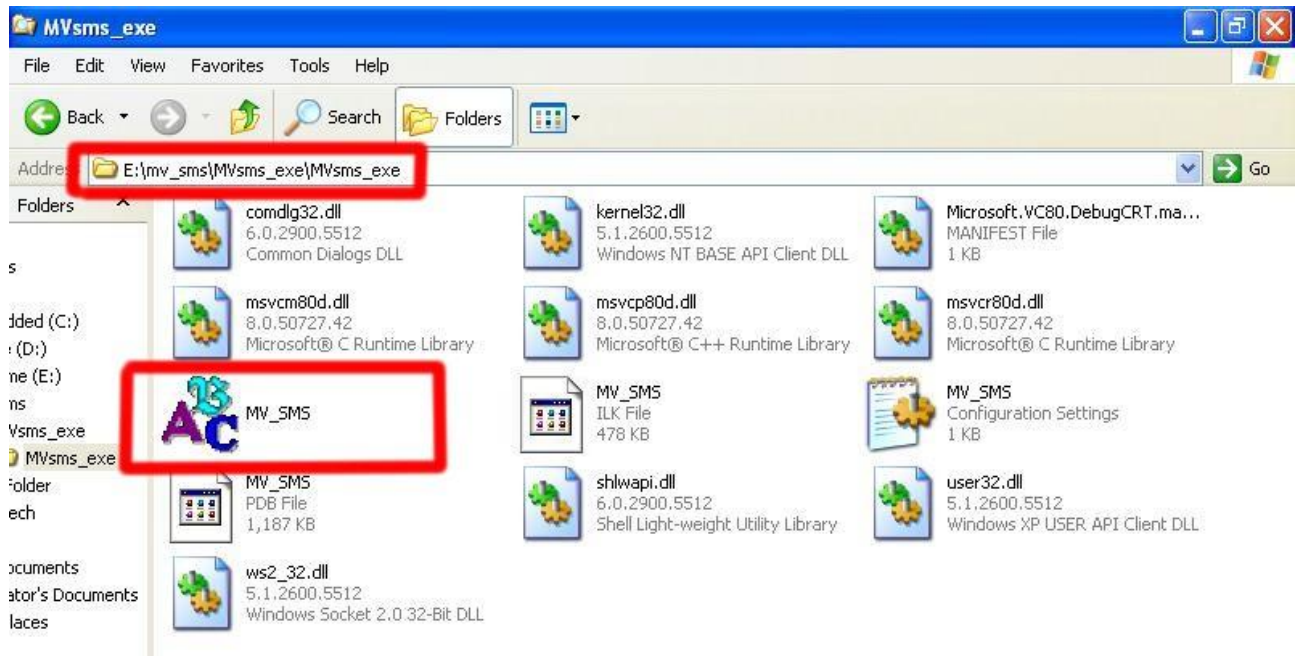

Step 8

1. Open File

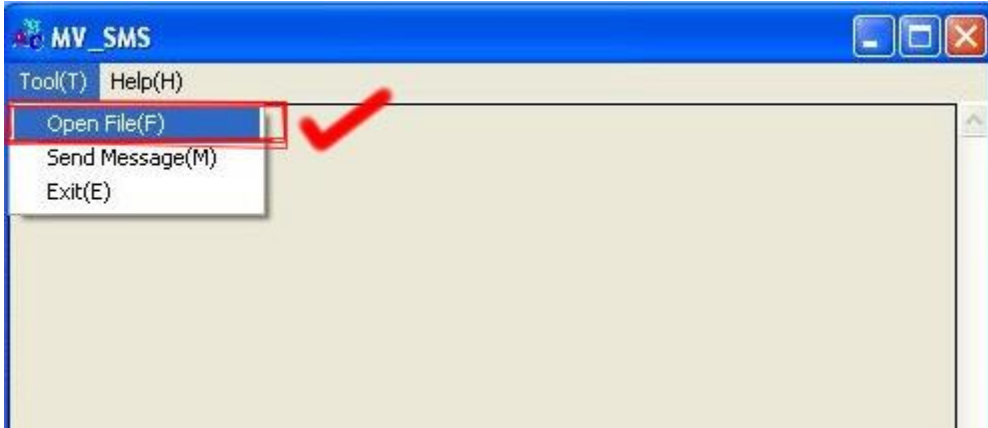

2. Open the "Excel file" that you just saved



Step 9

Sending

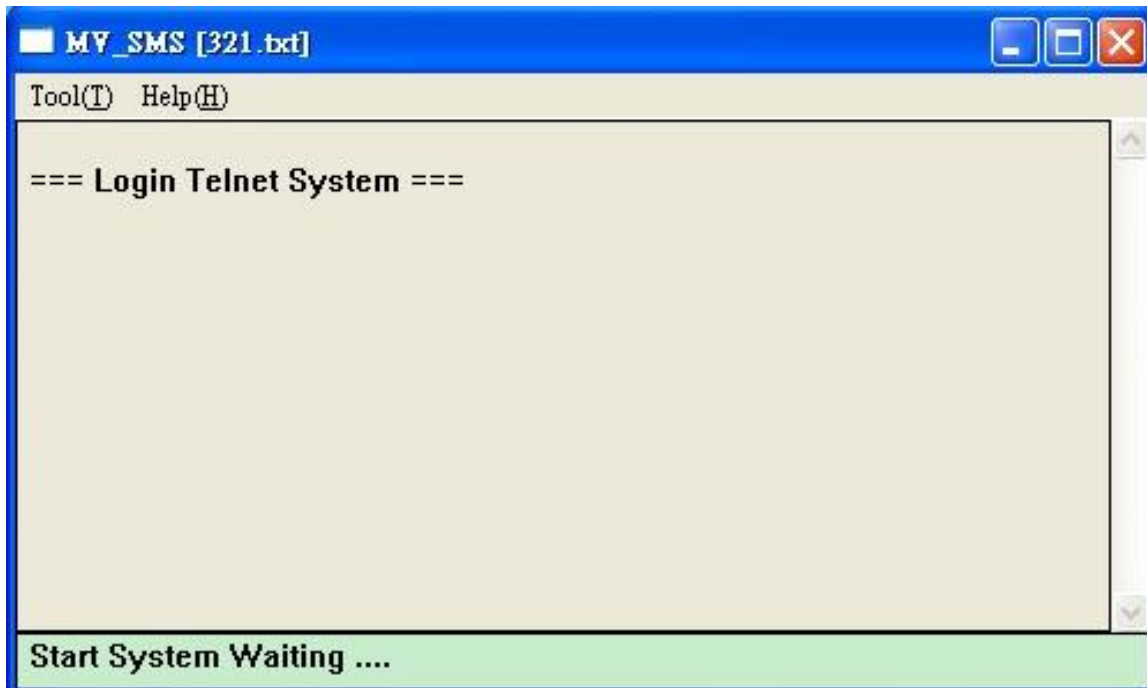

Step 10

Send SMS Complete

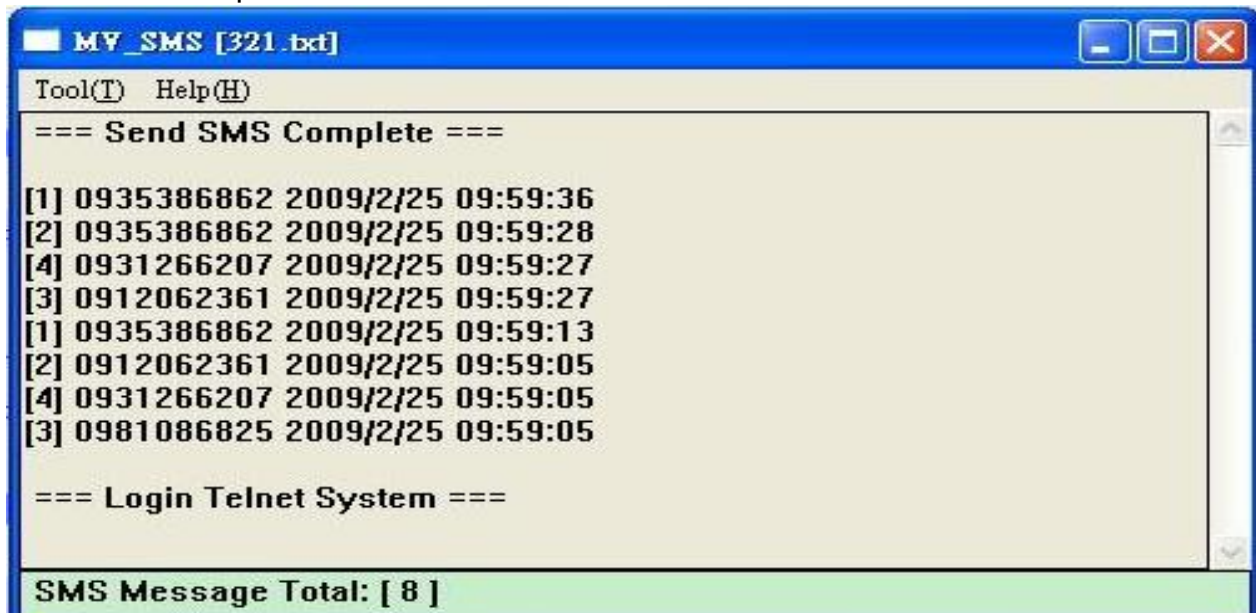

10.5 Use AT Command via Telnet or your program

Allows your program or Telnet Send/receive SMS with AT Command

Telnet PORT Corresponding port as follows:
(2 modules in one SLAVE)

SLAVE 1:1301

SLAVE 2:1302

SLAVE 3:1303

SLAVE 4:1304

SLAVE 5:1305

SLAVE 6:1306

SLAVE 7:1307

SLAVE 8:1308..... *MV-3716

SLAVE 9:1309

SLAVE 10:1310

SLAVE 11:1311

SLAVE 12:1312

SLAVE 13:1313

SLAVE 14:1314

SLAVE 15:1315

SLAVE 16:1316..... *MV-3732

```
username: voip  
password: ****  
user level = 1.
```

Please enter account
and password

```
command: logout, module, module1, module2.  
>module1  
getting module 1 ...  
got!! press 'ctrl-x' to release module 1.
```

Choose module

```
0  
ate1
```

Enter "ate1", then you can see
your at command below

```
0  
at+cmgf=1
```

```
0  
at+cmgs="0911123456"
```

Enter at+cmgs="phone number"

```
>  
test
```

Enter short message and ctrl+Z

```
>  
+CMGS: 30  
0
```

10.6 USSD SIM BaLANce Check via Telnet

```
5218 - 超級終端機
檔案(F) 編輯(E) 檢視(V) 呼叫(C) 轉送(T) 說明(H)
[Icons]
username: voip
password: ****
user level = admin.

command: logout, module1, module2, state1, state2, info.
!module1
getting module 1 ...
got!!! press 'ctrl-x' to release module 1.
0
at+cusd=1,"*145*11#"15
0
+CUSD: 2,"Accepted",0
0
release module 1 ...
```

1. USSD Request

2. Module command

連線 00:01:43 ANSIW TCP/IP SCROLL CAPS NUM 欄 列印

1. USSD Request: Please enter USSD code for your operator to check baLANce

2.

3. Module command:

Please enter "15" for Siemens BG2W module

Please enter "0" for Simcom module

✚ User can check this information on main page on **Module Description**

After sending the USSD request, MV will receive the SMS from operator
Please check the incoming SMS on SMS Agent



SMS Reader

Index	RemotelID	Date, Time
2	01145009310000990016	11/08/26, 15:24:43

帳單金額NT\$1836.0
付款期限8/28
累計未付金額NT\$1836.0
劃撥帳號 19037959
帳單號碼4046247121

Route

Mobile

Status

Settings

Fwd Settings

SMS Agent

SIM Setting

Operator Setting

Network

SIP Settings

STUN Setting

Update

System Authority

Save Change

Reboot

10.7 SIM Setting

PORTech
Your CTI Partner

Dial Peer
Route
Mobile
Status
Settings
SMS Agent
SIM Setting
Operator Setting
BCCH Info
USSD
Network
SIP Settings
STUN Setting
Update
System Authority
Save Change
Reboot

SIM Card Setting

Mobile 1, 2 ▼

CU ID: 1 (0001 ~ 9999, Server mode)

SIM Card of Mobile 1

Mode: Local Bank Server
Mobile ID: a0000000 Group: 1
Card ID: b0000000
Bank URL:
Server URL: 192.168.0.157:13000
Status: 0@0.0.0.0:0

SIM Card of Mobile 2

Mode: Local Bank Server
Mobile ID: a0000001 Group: 1
Card ID: b0000001
Bank URL:
Server URL: 192.168.0.157:13000
Status: 0@0.0.0.0:0

SubmitAll Submit Reset

1. CU ID: It's the ID for MV and SIM Server Transfer Protocol, within 1~9999. Each MV under same SIM Sever should setup different CU ID, and no reusing parameter. E.g. If you put "888" on 1st MV-3732 that you can't use "888" on 2nd MV-3732, and so on.
2. Mode
 - a. Local: Disable Remote SIM feature
 - b. Bank: Enable Remote SIM Bank feature, and manage SIM card on SBK-32 SIM Bank.
 - c. Server: Enable Remote SIM Server feature, and allocate SIM cards on SBK-32 SIM Bank.

3. Mobile

- a. ID: Put in 8 digits (hexadecimal, also base 16), which used for GSM Module ID identification to Remote SIM protocol. User can define the ID. IF it's Server Mode, just leave it default. If it's Bank Mode, No reusing GSM Module ID for same SIM Bank.
 - b. Group: Fill in SIM Group number for Remote GSM module. Server follow SIM Group Number to allocate SIM card to correspond GSM module
4. Card ID: Put in 8 digits (hexadecimal, also base 16), which used for SIM Card ID identification to Remote SIM protocol. User can define the ID. If it's in Server Mode, Card ID can be bLANK or default. As for Bank Mode, Card ID must be corresponding to SIM Card ID of SIM Bank.
 5. Bank URL: If it's Bank Mode, please fill SIM Bank IP and Port Number. On other hand, please leave bLANK for Server Mode.
 6. Server URL: If it's Server Mode, please fill SIM Server IP and Port Number. On other hand, please leave bLANK for Bank Mode.
 7. Status: User can check the SIM Card ID of GSM module and IP, Port Number of SIM bank.

After the setting, please click submit and save change button and wait for system reboot

10.8 Operator Setting

PORTech
Your CTI Partner

Dial Peer

Route

Mobile

Status

Settings

SMS Agent

SIM Setting

Operator Setting

BCCH Info

USSD

Network

SIP Settings

STUN Setting

Update

System Authority

Save Change

Reboot

Operator Setting

Mobile 1, 2 ▾

Mobile 1 :

Opreator ID (0: resume auto)

Work Mode Every time reset module Manual

Mobile 2 :

Opreator ID (0: resume auto)

Work Mode Every time reset module Manual

1. Operator ID: When GSM module is registered, user can click the List to show all available operators in that area. You will see like follows diagram.

Operator List

Mobile 1 ▾

No	Status	Name	ID	Use
00	Current	Chunghwa Telecom (CHT)	46692	<input type="radio"/>
01	Forbidden	Far EasTone (FET)	46601	<input type="radio"/>
02	Forbidden	Pacific GSM 1800 (TCC)	46697	<input type="radio"/>
03				<input type="radio"/>
04				<input type="radio"/>
05				<input type="radio"/>
06				<input type="radio"/>
07				<input type="radio"/>

2. Work Mode:

a. Every time reset module:

Fill the assigned Operator ID, then press **Submit** bottom and save change. After reboot, GSM module will research the operator ID and registered the base station.

b. Manual:

Fill the assigned Operator ID, then press **Now** bottom. GSM module will search that Operator ID and registered after reboot.

After the setting, please click submit and save change button and wait for system reboot

10.9 BCCH Info

Please work with this feature when the mobile status is “Stand by/Active”. It detects the surrounding active cell, up to 7 cells and shows Cell ID, signal and best signal (RXlev). The No.0 shows the data of current registered cell. Follow by No.1 to No.6 cell is based on cell signal (best to low).

NOTE: Support Quad band-BG2W, Quad band-M10 and firmware V10.185 above only.

PORTech
Your CTI Partner

BCCH Info

Mobile 1

select	MCC	LAC	Cell	BSIC	BCCH	RxLev
0	46692	0FAB	D3D2	14	31	-70
1	46692	0FAB	AC9D	10	30	-84
2	46692	0FAB	ACC2	11	49	-92
3	46692	0FAB	AC4E	14	28	-92
4	46692	0FAB	D3AD	14	34	-93
5	46692	0FAB	3790	8	572	-94
6	46692	0FAB	1140	10	43	-97

Refresh

	LAC	Cell ID	BCCH
<input type="checkbox"/> Preferred this Cell	0FAB	AC9D	30

Submit Reset

MCC : Mobile Country Code

LAC : Location Area Code

Cell : Cell Identifier

BSIC: Base Station Identity Code

BCCH: Broadcast Control Channel

RxLev: Received Signal level in dbm

How to Configure

1. You can choose a BCCH channel by clicking on the cell. The module will automatically register in the new BCCH.

E.g. If you would like to register BCCH channel on No.4 cell, please click no4 select like below.



The screenshot shows a web interface titled "Cell Info" with a dropdown menu set to "Mobile 1". Below the menu is a table with the following columns: select, MCC, LAC, Cell, BSIC, BCCH, and RxLev. The table contains seven rows of data. The row for cell No. 4 is highlighted with a red oval, and a red arrow points to the "select" column of that row. Below the table is a "Refresh" button.

select	MCC	LAC	Cell	BSIC	BCCH	RxLev
0	46601	0871	546F	20	629	-76
1	46601	0871	0000	20	661	-78
2	46601	0871	5470	21	640	-79
3	46601	0871	0000	23	513	-84
4	46601	0853	70AD	61	626	-89
5	46601	0853	70AE	61	532	-90
6	46601	0871	5278	46	649	-92

Refresh

2. System will show the cell number information once you select on Preferred this Cell form. Please click the submit button and Save Change, and wait for system reboot

select	MCC	LAC	Cell	BSIC	BCCH	RxLev
0	46601	0871	546F	20	629	-76
1	46601	0871	0000	20	661	-78
2	46601	0871	5470	21	640	-79
3	46601	0871	0000	23	513	-84
4	46601	0853	70AD	61	626	-89
5	46601	0853	70AE	61	532	-90
6	46601	0871	5278	46	649	-92

Refresh

	LAC	Cell ID	BCCH
<input checked="" type="checkbox"/> Preferred this Cell	0853	70AD	626

Submit Reset

After system restart and turn to Standby, please check on No.0 cell and confirm the current registered cell you selected. At the point, the GSM module won't provide the data of surrounding cell signal, but shows -110dbm on No.1 to No.6 RxLev, which means GSM signal 0.



The screenshot displays a table with 7 columns: select, MCC, LAC, Cell, BSIC, BCCH, and RxLev. The rows represent different cell IDs from 0 to 6. Cell 0 is highlighted with a red oval, indicating it is the selected cell. The RxLev for cell 0 is -88, while for cells 1 through 6, it is -110. A 'Refresh' button is located below the table.

select	MCC	LAC	Cell	BSIC	BCCH	RxLev
0	46601	0853	70AD	61	626	-88
1	46601	0871	546F	20	629	-110
2	46601	0871	546E	20	661	-110
3	46601	0871	0000	23	513	-110
4	46601	0853	0000	61	532	-110
5	46601	0853	0000	23	656	-110
6	46601	0871	0000	27	667	-110

Refresh

-
3. If you would like to research all the surrounding BCCH cells again, please cancel Preferred this Cell selection first and send Submit, Save Change to restart the gateway. That, System can detect the surrounding active cell, up to 6 cells and display Cell ID, signal and best signal (RXlev).



select	MCC	LAC	Cell	BSIC	BCCH	RxLev
0	46601	0871	546E	20	661	-76
1	46601	0871	546F	20	629	-77
2	46601	0871	5470	21	640	-79
3	46601	0871	0000	23	513	-83
4	46601	0853	70AE	61	532	-90
5	46601	0853	70AD	61	626	-89
6	46601	0871	5278	46	649	-92

Refresh

10.10 USSD (Unstructured Supplementary Service Data)

User can check USSD screen for SIM baLANce remaining and SIM recharge (add value) automatically. Please work with this feature when the mobile status is “Stand by/Active”. And ensure your Service provider has given you a USSD string(Command) for checking SIM BaLANce and Recharge the SIM Card.

The screenshot shows a web-based configuration interface for USSD services. On the left, a sidebar menu includes options like 'Route', 'Mobile', 'Status', 'Settings', 'Fwd Agent', 'SMS Agent', 'SIM Setting', 'Operator Setting', 'USSD' (highlighted with a red circle and arrow), 'Network', 'SIP Settings', 'STUN Settings', 'Update', 'System Authority', and 'Save Change'. The main content area is titled 'Rx Decoder: none' and contains three sections: 'Balance' with 'Cmd 1: *123*11#' and a 'Send' button; 'Recharge' with 'Cmd 2: *145*11#' and a 'Send' button, with a response 'C1F1B80CA797C9' displayed below; and 'Checking' with 'Cmd 3: at+cusd=1,"*145*11#",15' and a 'Send' button. At the bottom, there are 'Submit' and 'Reset' buttons.

1. BaLANce (SIM baLANce remaining)

Step1: Enter BaLANce checking USSD command in column

Step 2: Click Send button

When selected, system will check the baLANce of SIM and display the reply of receive message as below

This is an annotated version of the 'Balance' section from the previous screenshot. Red circles and arrows highlight specific elements: the command '*145*11#' in the 'Cmd 1' field is circled and labeled 'step1'; the 'Send' button is circled and labeled 'step2'; and the response '2,"Accepted",0' is circled and labeled 'receive message'.

2. Recharge (add value)

Step1: Enter the Recharging USSD command in column

Step 2: Click Send button

When selected, system will display the reply of receive message as below

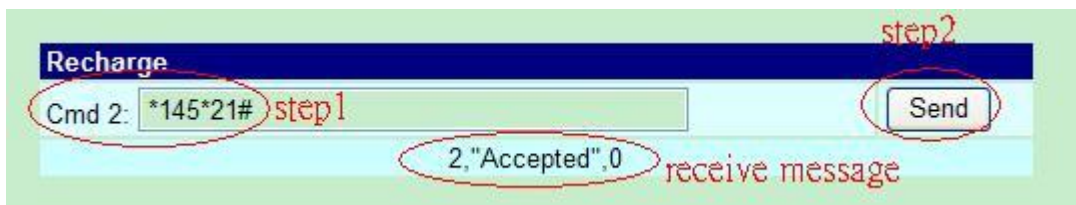

3. Checking (If above ways are failed, please select this)

Step 1: Enter the complete AT command in Cm3 column

Ex. **AT+CUSD=1,*145*11#,15**

Step 2: Click Send button

When selected, system will display the reply of receive message as below

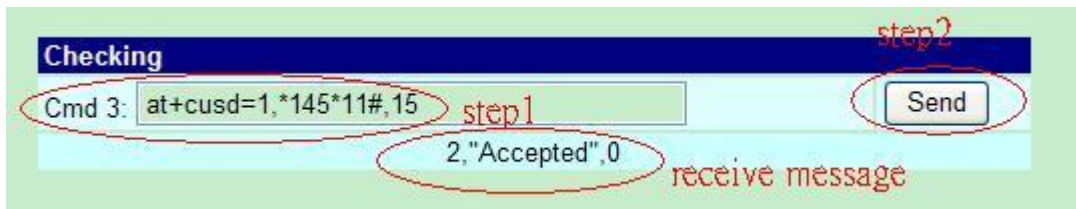

4. Rx Decoder

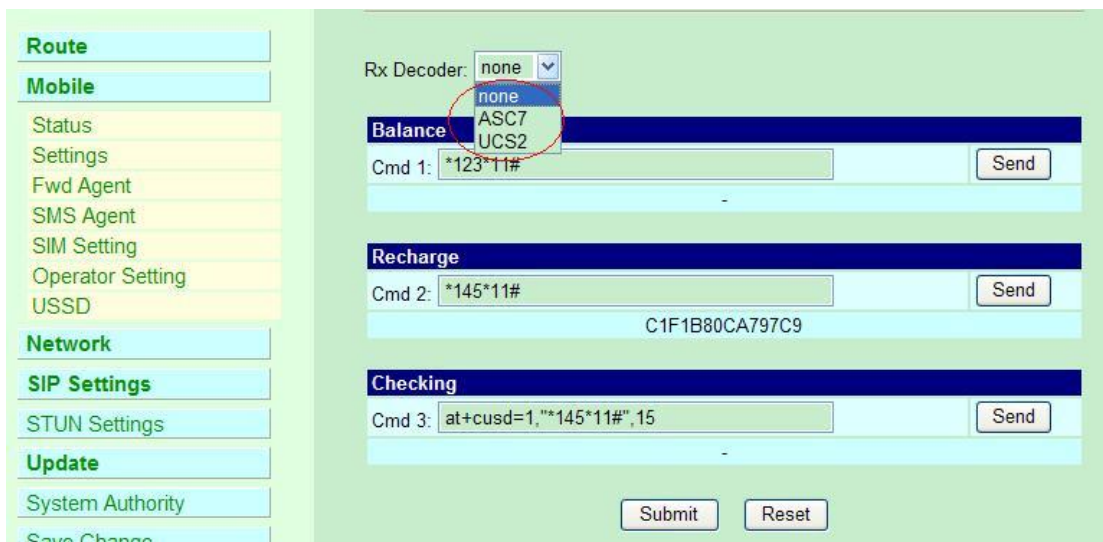

- a. None: GSM Format (Default)
- b. ASC7: ASCII 7bit
- c. UCS2: Unicode 16bit

When user select default GSM Format(None), it may not receive correct GSM code due to the different operator or GSM module/chipset. Please check below example,

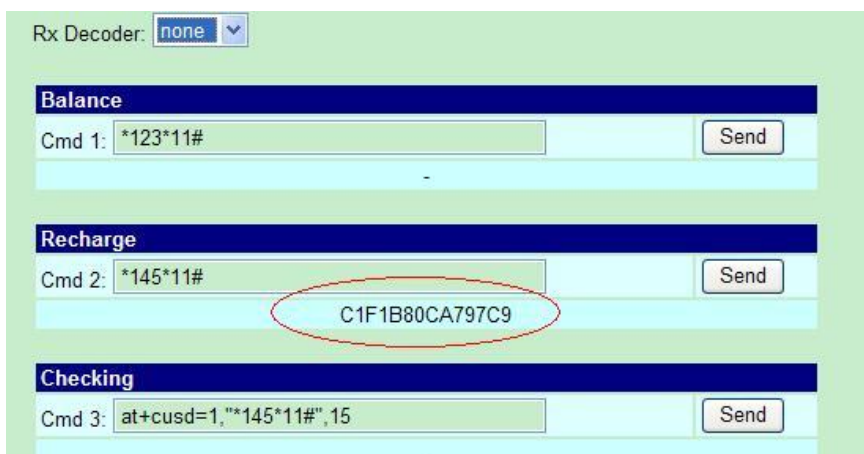

In this case, user need to select other RX Decoder (ASCII or UCS2) to receive correct message.

For Example,

None format: When user send command, “*145*11#”, the return message show on system, “C1F1B80CA797C9”

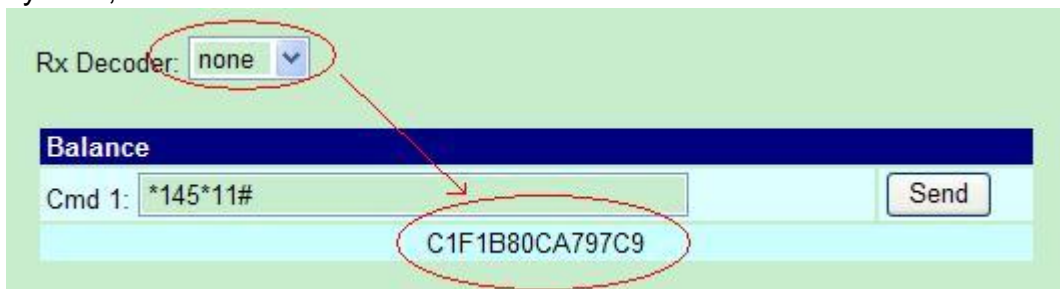

ASC7 Format: In this format, the return message is “Accepted”



11. Network

User can check the Network status and configure the WLAN Settings and SNTP settings.

11.1 WAN Setting

PORTech
Your CTI Partner

WAN Setting (RT)

WAN Settings	
IP Type	<input checked="" type="radio"/> Fixed IP <input type="radio"/> DHCP Client <input type="radio"/> PPPoE
Main IP	192.168.0.98
Mask	255.255.255.0
Gateway	192.168.0.254
DNS 1	168.95.192.1
DNS 2	168.95.1.1
MAC	00037E011BF2

PPPoE Settings	
Username	
Password	

Submit Reset

1. IP Type

- Fixed IP (Default IP: 192.168.0.100)
- DHCP Client
- PPPoE

2. Main IP: The current IP address. The IP changing need to under the Fixed IP mode.

3. PPPoE Setting

The PPPoE Configuration item is to setup the PPPoE Username and Password. If you have PPPoE account from the Service Provider, please input the Username and the Password correctly

After the setting, please click submit and save change button and wait for system reboot

11.2 SNTP Settings

User can setup the primary and second SNTP Server IP Address, to get the date/time information. Also you can base on your location to set the Time Zone, and how long need to synchronize again.

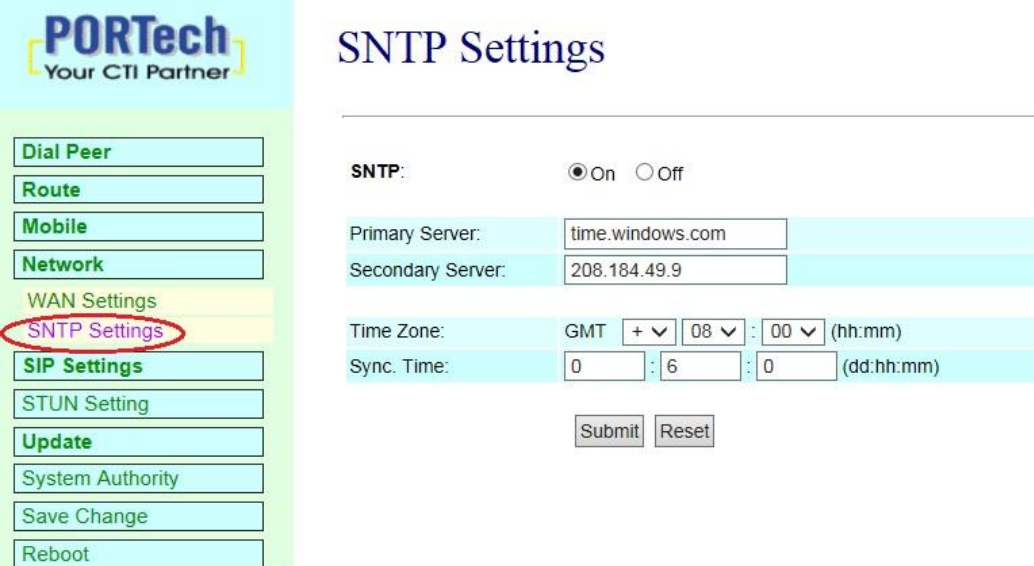

PORTech
Your CTI Partner

SNTP Settings

SNTP: On Off

Primary Server:

Secondary Server:

Time Zone: GMT : (hh:mm)

Sync. Time: : : (dd:hh:mm)

SNTP settings (Default: On)

After the setting, please click submit and save change button and wait for system reboot

12. SIP Setting

User can setup the Service Domain, Port Settings, Codec Settings, RTP setting, RPort Setting and Other Settings. If the VoIP service is provided by ISP, you need to setup the related information correctly then you can register to SIP Proxy Server correctly.

12.1 Service Domain Setting

In Service Domain Function you need to input the account and the related information in this page please refer to your ISP Provider. You can register three SIP accounts. You can dial the VoIP phone to your friends via first enable SIP account and receive the phone from the tree SIP account.

PORTech
Your CTI Partner

- Dial Peer
- Route
- Mobile
- Network
- SIP Settings**
- Service Domain
- Port Settings
- Codec Settings
- Codec ID Settings
- DTMF Settings
- SIP Responses
- Other Settings
- STUN Setting
- Update
- System Authority
- Save Change
- Reboot

Service Domain Settings

Mobile 1 ▾

Realm 1 (Default)	
Active:	<input type="radio"/> ON <input checked="" type="radio"/> OFF
Display Name:	<input type="text"/>
User Name:	<input type="text"/>
Register Name:	<input type="text"/>
Register Password:	<input type="text"/>
Domain Server:	<input type="text"/>
Proxy Server:	<input type="text"/>
Outbound Proxy:	<input type="text"/>
Status:	Not Registered

Realm 2	
Active:	<input type="radio"/> ON <input checked="" type="radio"/> OFF
Display Name:	<input type="text"/>
User Name:	<input type="text"/>
Register Name:	<input type="text"/>
Register Password:	<input type="text"/>
Domain Server:	<input type="text"/>
Proxy Server:	<input type="text"/>
Outbound Proxy:	<input type="text"/>
Status:	Not Registered

-
- (1) Active: On /OFF
 - (2) Display name: you can input the name you want to display.
 - (3) User name: you need to input the User Name get from your ISP.
 - (4) Register Name: you need to input the Register Name get from your ISP.
 - (5) Register Password: you need to input the Register Password get from ISP.
 - (6) Domain Server: you need to input the Domain Server get from your ISP.
 - (7) Proxy Server: you need to input the Proxy Server get from your ISP.
 - (8) Outbound Proxy: you need to input the Outbound Proxy get from your ISP. If your ISP does not provide the information, then you can skip this item.
 - (9) Status: Register or Not register

After the setting, please click submit and save change button and wait for system reboot

Example:

Register VoipBuster

Realm 1 (Default)	
Active:	<input checked="" type="radio"/> On <input type="radio"/> Off
Display Name:	<input type="text" value="jenny0922"/>
User Name:	<input type="text" value="jenny0922"/> Your Voipbuster username
Register Name:	<input type="text" value="jenny0922"/>
Register Password:	<input type="password" value="****"/> Your Voipbuster password
Domain Server:	<input type="text"/>
Proxy Server:	<input type="text" value="194.221.62.207"/> Proxy Server's IP
Outbound Proxy:	<input type="text"/>
Status:	Registered

12.2 Ports Setting

PORTech
Your CTI Partner

Port Setting (Rt)

Internal Dial Peer Port: (2000-59000)

MCH	SIP Port (2000~59000)	RTP Port (2000~59000)
1	5064	20004
2	5066	20006
3	5068	20008
4	5070	20010
5	5072	20012
6	5074	20014
7	5076	20016
8	5078	20018
9	5080	20020
10	5082	20022
11	5084	20024
12	5086	20026
13	5088	20028
14	5090	20030
15	5092	20032
16	5094	20034
17	5096	20036
18	5098	20038

Internal Dial Peer Port: default = **5060** (*important* this port number can't coincide with SIP port or RTP port)

SIP port: default = ch1:5064 ch2:5066 ch3:5068...etc (*important* this port number can't coincide with dial peer port or RTP port)

You can only change the port number on Ch1; other Channels will be changed automatically

RTP port: default = ch1:20004 ch2:20006 ch3:20008...etc (*important* this port number can't coincide with dial peer port or SIP port)

You can only change the port number on Ch1; other Channels will be changed automatically

After the setting, please click Submit and save change button to wait for system reboot

12.3 Codec Settings:

User can setup the Codec priority, RTP packet length in this page. Please follow the ISP suggestion to setup these items.

PORTech
Your CTI Partner

Dial Peer
Route
Mobile
Network
SIP Settings
Service Domain
Port Settings
Codec Settings
Codec ID Settings
DTMF Settings
SIP Responses
Other Settings
STUN Setting
Update
System Authority
Save Change
Reboot

Codec Settings

Codec Priority	
Codec Priority 1:	G.711 u-law
Codec Priority 2:	G.711 a-law
Codec Priority 3:	G.723
Codec Priority 4:	G.729
Codec Priority 5:	G.726 - 16
Codec Priority 6:	G.726 - 24
Codec Priority 7:	G.726 - 32
Codec Priority 8:	G.726 - 40

RTP Packet Length	
G.711 & G.729:	20 ms
G.723:	30 ms

G.723 5.3K	
G.723 5.3K:	<input type="radio"/> On <input checked="" type="radio"/> Off

Voice VAD	
Voice VAD:	<input type="radio"/> On <input checked="" type="radio"/> Off

Submit Reset

RTP Packet Length

1. G.711 & G.729: Default is 20ms.
Range: 10ms, 20ms, 30ms, 40ms, 50ms, 60ms, 70ms, 80ms, 90ms
2. G.723: Default:
Range: 30ms, 60ms, 90ms

After the setting, please click Submit and save change button to wait for system reboot

12.4 Codec ID Setting

User can setup the Codec ID in this page.
After the setting, please click Submit and save change button to wait for system reboot

PORTech
Your CTI Partner

Dial Peer
Route
Mobile
Network
SIP Settings
Service Domain
Port Settings
Codec Settings
Codec ID Settings
DTMF Settings
SIP Responses
Other Settings
STUN Setting
Update
System Authority
Save Change
Reboot

Codec ID Setting

Codec Type	ID	Default Value
G726-16 ID:	<input type="text" value="23"/> (95~255)	<input checked="" type="checkbox"/> 23
G726-24 ID:	<input type="text" value="22"/> (95~255)	<input checked="" type="checkbox"/> 22
G726-32 ID:	<input type="text" value="2"/> (95~255)	<input checked="" type="checkbox"/> 2
G726-40 ID:	<input type="text" value="21"/> (95~255)	<input checked="" type="checkbox"/> 21
RFC 2833 ID:	<input type="text" value="101"/> (95~255)	<input checked="" type="checkbox"/> 101

12.5 DTMF Setting

PORTech
Your CTI Partner

DTMF Setting

DTMF Transfer Mobile to LAN

Format 2833 Inband SIP Info

Mobile DTMF Detection

Duration (0 ~ 999, -1: unlimit, unit: 1s) .

Debounce (40 ~ 500, default: 80 , unit: 10ms).

SIP Settings

- Service Domain
- Port Settings
- Codec Settings
- Codec ID Settings
- DTMF Settings**
- SIP Responses
- Other Settings

STUN Setting

Update

System Authority

Save Change

Reboot

1. Format:

- 2833: Default RFC2833, the type of DTMF Data Transfer Format
- Inband: The Type of Inband DMTF Data Transfer Format
- SIP Info: The Type of SIP-Info DMTF Data Transfer Format;

2. Duration: Default is -1. It's the duration for MV-3716/MV-3732 to defect sender's DTMF. If the parameter is 0, MV-3716/MV-3732 won't detect sender's DTMF. Parameter is 0~999 seconds. After that duration, MV-3716/MV-3732 won't detect DTMF.

3. Debounce: Default is 80ms. User can adjust for own. If DTMF is adding more digits, please increase parameter over 80. If DMTF is lost digit, please decrease parameter less than 80.

After the setting, please click Submit and save change button to wait for system reboot

12.6 SIP Responses

PORTech
Your CTI Partner

Dial Peer
Route
Mobile
Network
SIP Settings
Service Domain
Port Settings
Codec Settings
Codec ID Settings
DTMF Settings
SIP Responses
Other Settings
STUN Setting
Update
System Authority
Save Change
Reboot

SIP Responses

2013-06-05 16:37

Mobile Busy Response	
Unavailable	486 Busy here
Ring Timeout	486 Busy here

SIP Ring Responses	
<input checked="" type="radio"/> ON <input type="radio"/> OFF	180 Ringing (Force to ON, if 183 was OFF.)
<input type="radio"/> ON <input checked="" type="radio"/> OFF	183 Session Progress

submit reset

Mobile Busy Response

1. Unavailable: User can setup the SIP response code of LAN side while the call dial failed or in busy line
 - a. 486 Busy Here (Default)
 - b. 503 Service unavailable
 - c. 480 Temporarily unavailable
2. Ring Timeout: User can setup the response SIP code of LAN side while operators hang up the no answered calls
 - a. 486 Busy Here (Default)
 - b. 503 Service unavailable
 - c. 480 Temporarily unavailable

SIP Ring Response

1. 180 Ring on/off:

LAN TO MOBILE two stage dialing can be turn off, therefore there will be no the Ring Back Tone, all the phone call will be transferred to prompt voice directly. (For this function, 183 must be turn on)

2. 183(Session Progress)

[It means "on progressing"]: When you turn 183 on, it means you can hear the prompt voice while GSM side is busy we recommend you to turn this on if you use SIP Proxy.

After the setting, please click Submit and save change button to wait for system reboot

12.7 Other Settings

User can setup the Hold by RFC and QoS in this page. To change these settings, please follow your ISP information. The QoS setting is to set the voice packets' priority. If you set the value higher than 0, then the voice packets will get the higher priority to the Internet. But the QoS function still need to cooperate with the others Internet devices.

PORTech
Your CTI Partner

Dial Peer

Route

Mobile

Network

SIP Settings

Service Domain

Port Settings

Codec Settings

Codec ID Settings

DTMF Settings

SIP Responses

Other Settings

STUN Setting

Update

System Authority

Save Change

Reboot

Other Setting

Mobile 1, 2 ▼

Hold by RFC of Mobile 1 ON OFF

Hold by RFC of Mobile 2 ON OFF

Voice QoS: (0~63)

SIP QoS: (0~63)

SIP Expire Time: (30~86400 sec)

1. Hold RFC of Mobile:
 - a. On: To activate Hold RFC of Moible
 - b. OFF (Default)
2. Voice QoS : The setting of Voice QoS, Default is 40
3. SIP QoS : The setting of SIP QoS, Default is 40
4. SIP Expire Time : The setting of SIP Expire Time, Default is 40

After the setting, please click Submit and save change button to wait for system reboot

You can click Submit All to copy to Mobile setting, and select Yes and save change to wait for the system reboot

13. STUN Setting

User can setup the STUN Enable/Disable and STUN Server IP address in this page. This function can help your VoIP device working properly behind NAT. Please following your ISP information to change the settings

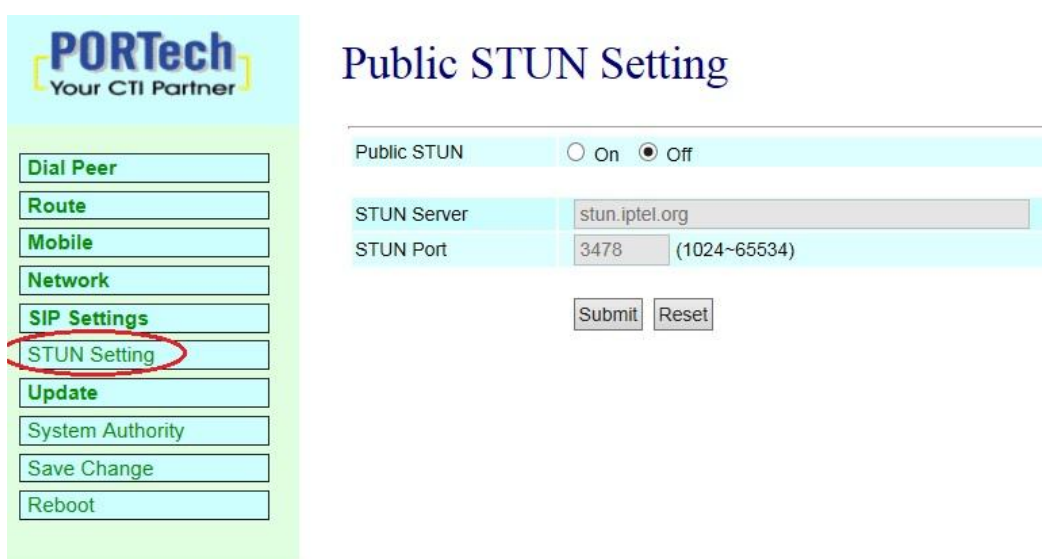

PORTech
Your CTI Partner

Public STUN Setting

Public STUN On Off

STUN Server

STUN Port (1024~65534)

Dial Peer
Route
Mobile
Network
SIP Settings
STUN Setting
Update
System Authority
Save Change
Reboot

Public STUN OFF → Default is OFF; While the WAN setting of MV-3716/MV-3732 is in Static IP or Private IP please selects Public STUN OFF.

Public STUN ON → While MV-3716/MV-3732 is working under Firewall or behind NAT, It will cause SIP can't register, or one side communicate, please select Public STUN ON.

STUN Server→ The STUN Server IP (Default: stun.iptel.org)

STUN Port→ The STUN Port (Default: 3478)

After the setting, please click Submit and save change button to wait for system reboot

14. Update

14.1 Update Firmware

User can update the system's firmware to the new one or the factory reset to let the system back to default setting.

NOTE: Please open the webpage from Internet Explorer, not compatible with FF or Google Chrome

PORTech
Your CTI Partner

Update Firmware
Ver = v10.272 , GZ = r4nat , PCB = 3748NAT .

HTTP

Code Type: RISC ▾

File Location: Browse...

Submit Reset

Dial Peer
Route
Mobile
Network
SIP Settings
STUN Setting
Update
New Firmware
Default Settings
System Authority
Save Change
Reboot

Step:

- (1) Select the firmware code type, Risc code only.
- (2) Click the "Browse" button in the right side of the File Location or you can type the correct path and the filename in File Location bLANK.
- (3) Select the correct file you want to download to the system then click the Update button.
- (4) Please click update/default setting after update firmware

14.2 Default Settings



Restore Default Settings

Restore default settings:

Restore factory all settings: (included all IP address)

1. Restore default settings: User can restore the factory default settings to the system. All setting will restore default setting. The device IP still is the user original IP.
2. Restore factory all settings: All setting will be restored to default setting. The device IP will be back to 192.168.0.100

15. System Authority

User can change the login name and password



PORTech
Your CTI Partner

Dial Peer
Route
Mobile
Network
SIP Settings
STUN Setting
Update
System Authority
Save Change
Reboot

System Authority

New username:

New password:

Confirmed password:

16. Save Change

User can save the changes after the setting is done. If you want to use new setting in the VoIP system, you have to click the Save button. After you click the Save button, the system will automatically restart



Save Changes

You have to save changes to effect them.

Save Changes:

17. Reboot

User can restart the system. If you want to restart the system, you can just click the Reboot button, and then the system will automatically.



PORTech
Your CTI Partner

Dial Peer

Route

Mobile

Network

SIP Settings

STUN Setting

Update

System Authority

Save Change

Reboot

Reboot System

Reboot system:

18. Specification

18.1 Protocols

SIP (RFC2543, RFC3261)

18.2 TCP/IP

IP/TCP/UDP/RTP/RTCP/

CMP/ARP/RARP/SNTP

DHCP/DNS Client

IEEE802.1P/Q

ToS/DiffServ

NAT Traversal

STUN

uPnP

IP Assignment

Static IP

DHCP

PPPoE

18.3 Codec

G.711 u-Law

G.711 a-Law

G.729A

G.729A/B

18.4 Voice Quality

VAD

CNG

AEC, LEC

Packet loss

18.5 GSM (MV-3716/MV-3732)

Quad Band: 900/1800/1900/850MHZ

3G/UMTS: for all world and Japan (SoftBank and Docomo)

3G: EDGE/GPRS 850, 900, 1800, 1900 MHz / HSDPA/UMTS 850, 1900, 2100 MHz

CDMA 2000(800MHZ/1900MHZ)

****Please note****

1. Most CDMA -2000 operators don't offer Answer signal.

So VoIP to Mobile, MV-3716/MV-3732 will connect soon.

CDMA -2000 operators will start billing soon. It doesn't wait mobile side answer

2. CDMA Version doesn't support SMS Feature and 180/183 unavailable

3. CDMA version doesn't have Remote SIM feature

19. Simple Steps

Step 1. Change the Network setting as you need (Network/network setting)

Step 2. Register SIP proxy Server or Asterisk or VoipBuster as you need
(sip setting/service domain)

Step 3. Set Mobile setting –adjust your gain as you need

Step 4. Set Route (**request**)

mobile to LAN:	
(1)	*,* --->it is two stage dialing.
	when mobile call in,MV-37x will provide dial tone and you can enter ip or asterisk extension or phone number.
	* If you want to enter phone number, please note your asterisk need to have route of destination number.
(2)	*, specific extension or IP or phone number
	when mobile call in,MV-37x will connect with this specific extension or IP or phone number auto
	* If you want to set specific phone number, please note your asterisk need to have route of destination number.
LAN to Mobile:	
(1)	*,* --->it is two stage dialing.
	When LAN phone call in, MV-37x will provide dial tone and you can enter mobile number.
(2)	*, specific mobile number
	When LAN phone call in, MV-37x will connect with the specific mobile number auto.
(3)	*,#--->It is 1 stage dialing
	When LAN phone and MV-37x both register Asterisk, you can dial any destination number from LAN phone directly.
	* Please note: Asterisk need to set route of destination number that dial out from MV-37x

* All changes both need to click "save and change"

20. Appendix: Setup MV-37x with Asterisk

MV-37x Settings

PORTech
Your CTI Partner

- Route
- Mobile
- Status
- Settings**
- Fwd Settings
- SMS Agent
- Network
- SIP Settings
- STUN Setting
- Update
- System Authority
- Save Change
- Reboot

Mobile Setting

Mobile 1, 2

VoIP Tx Gain:	9 (0~12)	VoIP Rx Gain:	11 (0~15)
LAN Dialtone Vol:	9 (0~12)		
Mobile 1 <input checked="" type="radio"/> ON <input type="radio"/> OFF			
Routing Range	0 to 49 (0~49)		
CODEC Tx Gain:	6 (0~7)	CODEC Rx Gain:	6 (0~7)
SIP From:	Tel/Tel (Not Reg)	Answer Delay	0 (0~15)
CLID Presentation	<input type="radio"/> Suppression <input checked="" type="radio"/> Invocation		
Mobile PIN Code:	On <input type="checkbox"/> Code: <input type="text"/>	Confirmed:	<input type="text"/>
LAN Answer Mode	<input checked="" type="radio"/> Answered <input type="radio"/> Alerted <input type="radio"/> Income		

Asterisk want to transfer CLID, please choose Tel/Tel (Not Reg)

Mobile Voip

- Route
- Mobile
- Network
- SIP Settings
- Service Domain**
- Port Settings
- Codec Settings
- Codec ID Setting
- DTMF Setting
- RPort Setting
- SIP Responses
- Other Settings
- STUN Setting

Service Domain Settings

Mobile 1

Realm 1 (Default)	
Active:	<input checked="" type="radio"/> ON <input type="radio"/> OFF
Display Name:	<input type="text"/>
User Name:	<input type="text"/>
Register Name:	<input type="text"/>
Register Password:	<input type="text"/>
Domain Server:	192.168.0.192:5060
Proxy Server:	192.168.0.192:5060
Outbound Proxy:	<input type="text"/>
Status:	Not Registered

Can register Asterisk or not

PORTech
Your CTI Partner

Route

Mobile To Lan Settings
Mobile To Lan Speed Dial
Lan To Mobile Settings
Dial Peer Status

Mobile

Network

SIP Settings

STUN Setting

Update

System Authority
Save Change
Reboot

Mobile To LAN Table

Mobile 1, 2 ▾

Set your Asterisk IP or extension or *

Page: 1 ▾

Item	CID	URL	Select
0	*	192.168.0.192	<input type="checkbox"/>
1			<input type="checkbox"/>
2			<input type="checkbox"/>
3			<input type="checkbox"/>
4			<input type="checkbox"/>
5			<input type="checkbox"/>
6			<input type="checkbox"/>
7			<input type="checkbox"/>
8			<input type="checkbox"/>
9			<input type="checkbox"/>

PORTech
Your CTI Partner

Route

Mobile To Lan Settings
Mobile To Lan Speed Dial
Lan To Mobile Settings
Dial Peer Status

Mobile

Network

SIP Settings

STUN Setting

Update

System Authority
Save Change
Reboot

LAN To Mobile Table

Mobile 1, 2 ▾

As Asterisk GSM
Route

Page: 1 ▾

Item	URL	Call Num	Select
0	*	#	<input type="checkbox"/>
1			<input type="checkbox"/>
2			<input type="checkbox"/>
3			<input type="checkbox"/>
4			<input type="checkbox"/>
5			<input type="checkbox"/>
6			<input type="checkbox"/>
7			<input type="checkbox"/>
8			<input type="checkbox"/>
9			<input type="checkbox"/>

Dial Peer Setting

Dial Peer

Status
Settings

Route

Mobile

Network

SIP Settings

STUN Setting

Update

System Authority

Save Change

Reboot

Transfer SIP Message

Yes No Replace contact to Dial Peer.

SIP Response when all busy.

600 Busy Everywhere (default)
 408 Request Timeout

Dial Peer

Working Mode OFF Internal External

External URL ([Dial Peer for XP](#))

Submit

Reset

PORTech
Your CTI Partner

- Route
- Mobile
- Network
- SIP Settings**
 - Service Domain
 - Port Settings
 - Codec Settings
 - Codec ID Setting
 - DTMF Setting
 - RPort Setting
 - SIP Responses
 - Other Settings
- STUN Setting
- Update
- System Authority

Ports Setting

Internal Dial Peer Port: (1024~19900)

	SIP Port (1024~19900)	RTP Port (20000~59900)
Mobile 1	<input type="text" value="5064"/>	<input type="text" value="20004"/>
Mobile 2	<input type="text" value="5066"/>	<input type="text" value="20006"/>
Mobile 3	<input type="text" value="5068"/>	<input type="text" value="20008"/>
Mobile 4	<input type="text" value="5070"/>	<input type="text" value="20010"/>
Mobile 5	<input type="text" value="5072"/>	<input type="text" value="20012"/>
Mobile 6	<input type="text" value="5074"/>	<input type="text" value="20014"/>
Mobile 7	<input type="text" value="5076"/>	<input type="text" value="20016"/>
Mobile 8	<input type="text" value="5078"/>	<input type="text" value="20018"/>

Don't forget to Save changes and then reboot

Asterisk / Trixbox setting

Add SIP Trunk:

Edit SIP Trunk

[Delete Trunk SIM1](#)

[In use by 1 route](#)

General Settings

[Outbound Caller ID:](#) Type your mobile number

[Never Override CallerID:](#)

[Maximum channels:](#) MV-374: 4
MV-378: 8

Outgoing Dial Rules

[Dial Rules:](#)

[Dial rules wizards:](#)

[Outbound Dial Prefix:](#)

Outgoing Settings

Trunk Name:

PEER Details:

```
host=192.168.0.111
port=5060
type=peer
```

Type MV-37X's IP and port

Set GSM Route that dial out via MV-37X

After change, please press **“Submit changes”** and **“apply configuration changes”**

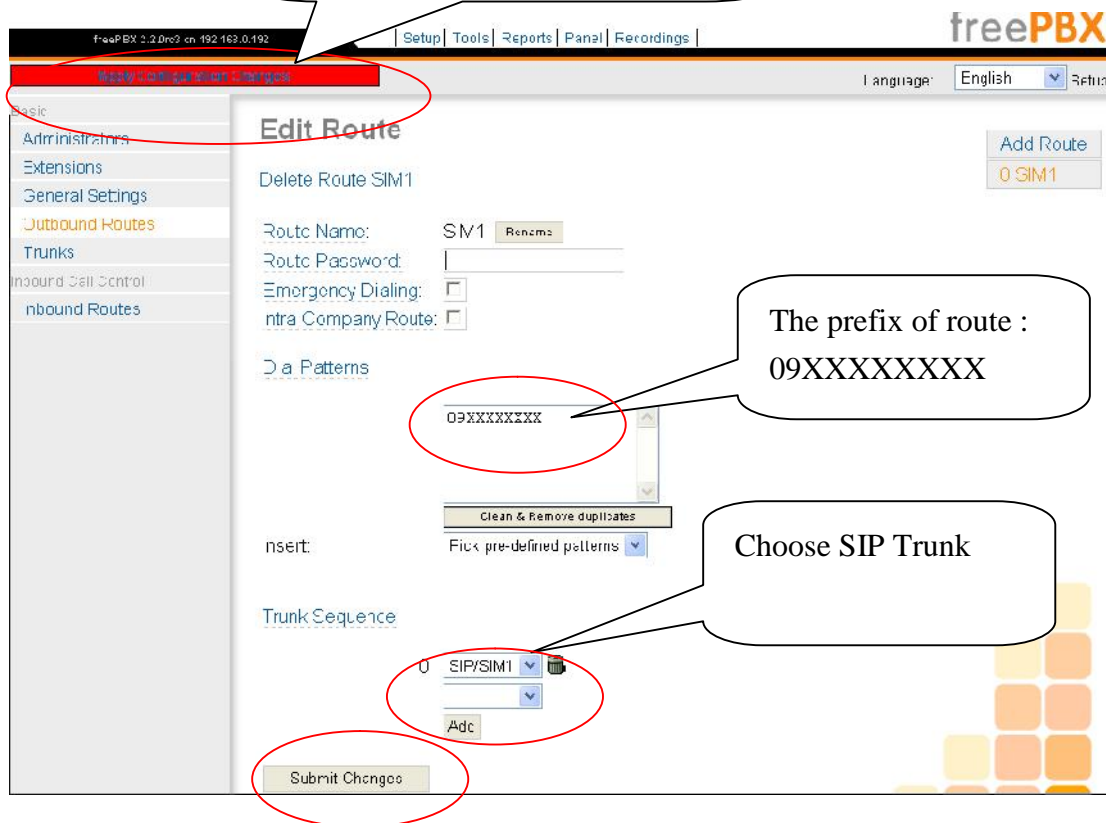

Frequency: Quad Band:900/1800/1900/850MHZ

GSM Module use Simcom sim340

Compliant to GSM phase 2/2+

-Class 4 (2W@850/900 MHz)

-Class 1 (1W@1800/1900 MHz)

15.21

Federal Communications Commission (FCC) Statement

You are cautioned that changes or modifications not expressly approved by the part responsible for compliance could void the user's authority to operate the equipment.

15.105(b)

Federal Communications Commission (FCC) Statement

This equipment has been tested and found to comply with the limits for a Class B digital device, pursuant to part 15 of the FCC rules. These limits are designed to provide reasonable protection against harmful interference in a residential installation. This equipment generates, uses and can radiate radio frequency energy and, if not installed and used in accordance with the instructions, may cause harmful interference to radio communications. However, there is no guarantee that interference will not occur in a particular installation. If this equipment does cause harmful interference to radio or television reception, which can be determined by turning the equipment off and on, the user is encouraged to try to correct the interference by one or more of the following measures:

- Reorient or relocate the receiving antenna.
- Increase the separation between the equipment and receiver.
- Connect the equipment into an outlet on a circuit different from that to which the receiver is connected.
- Consult the dealer or an experienced radio/TV technician for help.

Operation is subject to the following two conditions:

- 1) this device may not cause interference and
- 2) this device must accept any interference, including interference that may cause undesired operation of the device.

FCC RF Radiation Exposure Statement:

1. This Transmitter must not be co-located or operating in conjunction with any other antenna or transmitter.
2. This equipment complies with FCC RF radiation exposure limits set forth for an uncontrolled environment. This equipment should be installed and operated with a minimum distance of 20 centimeters between the radiator and your body.